

General informations

Item information

For individual items, the dimensions can be read from the item number.

- Gaskets – GD5201-G30 | Width 50 mm / Fire protection G30
- Cover and pressure plates – DL6067-ELO | Width 60 mm / anodized

Articles with article numbers beginning with 50 or 60 are for systems with a width of 50 mm or 60 mm.

Articel availability

Normally all items listed with a price are in stock and can be delivered immediately.

Packing units [PU]

- Gaskets (GD) 25 m in a box (unless otherwise specified)
- Screws and bolts, depending on the version, 100 pieces or 200 pieces in a box
- Tubes, profiles and bar stock per specified storage length
- Special accessories, tools and various small parts per version 1 pc. Or 10 pc.

Order quantities that differ from the packaging units [PU] are confirmed and delivered in the next higher PU.

With surface-processed cover strips, the usable length is reduced by approx. 50 mm at the profile ends.

Special lengths for bar goods (screw tubes, T-profiles, top, cover and bottom strips) on request.

The technical drawings shown in the price list are not to scale.

For technical details, see product information.

We do not accept any liability for errors or misprints.

Order

Please fax or email your order to our order processing department:

Fax: **+49 228 909043-11**
Mail: **c.service@stabalux.com**

Stabalux GmbH
Fraunhoferstr. 8
53121 Bonn - Germany
Phone +49 228 909043-0

Stabalux SR - Threaded tubes | Sendzimir-galvanized and stainless steel

Item	Designation	Dimension	kg/m	PU	[..]
System 50					
SR5040-2-6000	SR tube S280 galvanized	50x40x2 6000 mm	3,4	6	m
SR5090-2-6000	SR tube S280 galvanized	50x90x2 6000 mm	5,0	6	m
SR50120-2-8000	SR tube S280 galvanized	50x120x2 8000 mm	5,9	8	m
SR50150-3-7500	SR tube S280 galvanized	50x150x3 7500 mm	10,3	7,5	m
System 60					
SR6040-2-6000	SR tube S280 galvanized	60x40x2 6000 mm	3,7	6	m
SR6060-2-6000	SR tube S280 galvanized	60x60x2 6000 mm	4,4	6	m
SR6090-2-6000	SR tube S280 galvanized	60x90x2 6000 mm	5,3	6	m
SR6090-2-10000	SR tube S280 galvanized	60x90x2 10000 mm	5,3	10	m
SR6090-4-8000	SR tube S280 galvanized	60x90x4 8000 mm	10,0	8	m
SR60130-3-D-8000	SR tube S280 galvanized	60x130x3 8000 mm	8,8	8	m
SR60140-2-6000	SR tube S280 galvanized	60x140x2 6000 mm	6,9	6	m
SR60140-2-10000	SR tube S280 galvanized	60x140x2 10000 mm	6,9	10	m
SR60140-4-8000	SR tube S280 galvanized	60x140x4 8000 mm	13,2	8	m
SR60180-3-T-10000	SR tube S280 galvanized	60x180x3 10000 mm	12,8	10	m
SR60180-3-9000	SR tube S280 galvanized	60x180x3 9000 mm	12,2	9	m
SR60200-5-10000	SR tube S280 galvanized	60x200x5 10000 mm	21,1	10	m
AL9090	AL tube corner profile	90x90 6000 mm	3,5	6	m

Special lengths that can be produced within the production cycle are supplied at no extra charge.

Dates have to be agreed.

Stabalux SR - End caps

Caps for screw tubes

(made of 2 mm galvanized sheet steel)

Item	Designation	Dimension	PU	[..]
Z5045	Cap	for SR5040-2	10	pc.
Z5046	Cap	for SR5090-2	10	pc.
Z5047	Cap	for SR50150-3	10	pc.
Z6046	Cap	for SR6040-2	10	pc.
Z6101	Cap	for SR6060-2	10	pc.
Z6047	Cap	for SR6090-2	10	pc.
Z6050	Cap	for SR6090-4	10	pc.
Z6048	Cap	for SR60140-2	10	pc.
Z6051	Cap	for SR60140-4	10	pc.
Z6056	Cap	for SR60180-3	10	pc.
Z6052	Cap	for SR60180-5	10	pc.



Stabalux SR - Threaded tubes | Sendzimir-galvanized and stainless steel

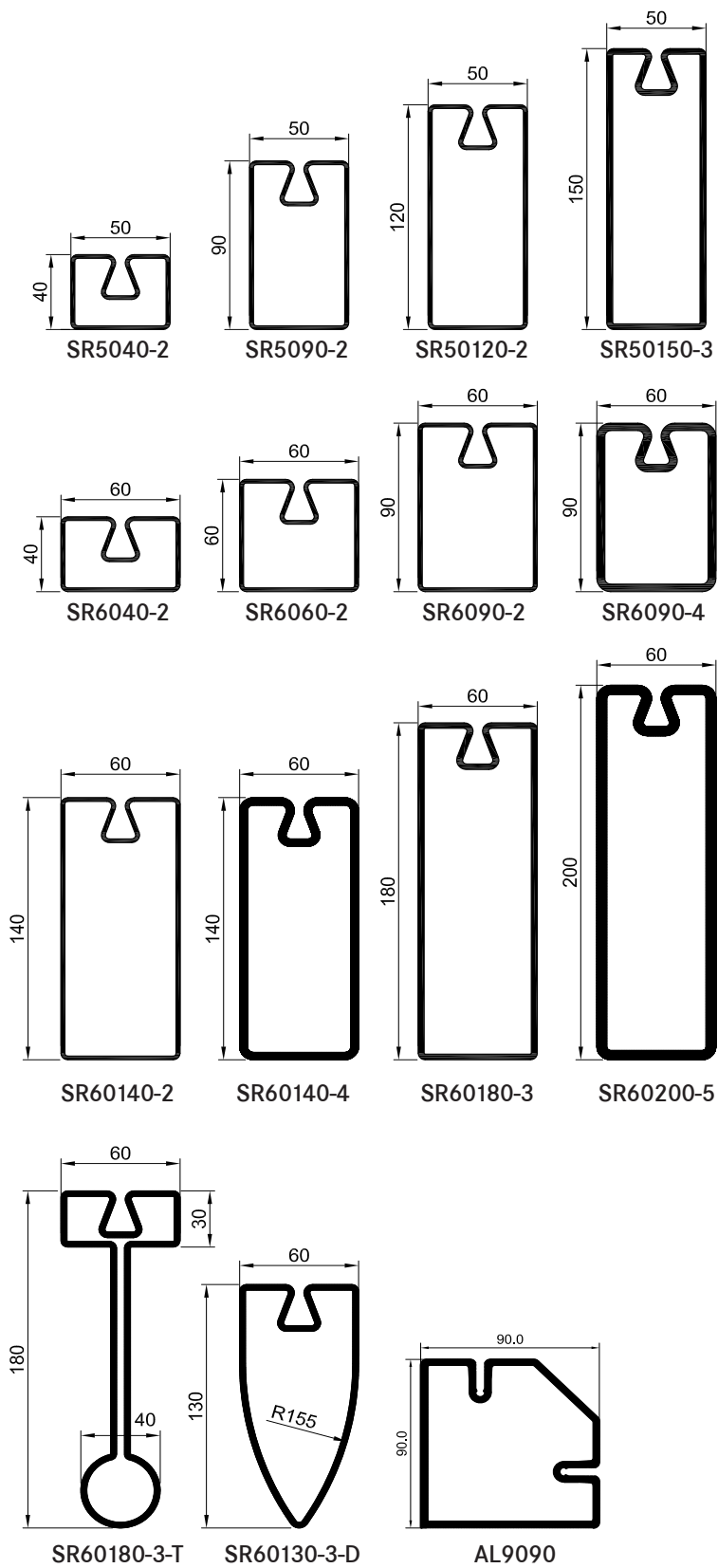

Stabalux SR - Mullion-Transom-Connector

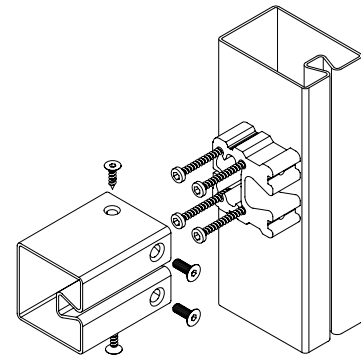

T-Connector aluminum (for max. 2 mm wall thickness in the transom)

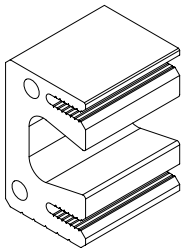

Item	Designation	Dimensions	System	PU	[..]
RHT9009	T-Connector	44 x 34 x 40 mm (2)	50	1	pc.
RHT9010	T-Connector	54 x 34 x 40 mm (2)	60	1	pc.
RHT9109	T-Connector (polygonal)	44 x 34 x 60 mm (2)	50	1	pc.
RHT9110	T-Connector (polygonal)	54 x 34 x 60 mm (2)	60	1	pc.

Screws



Item	Designation	Dimensions	PU	[..]
Z0147	Screw for T-Connector	6,5 x 55 mm	100	pc.
Z0120	Fixing screw transom	4,8 x 16 mm	100	pc.

the processing instructions & drilling patterns for the RHT in chap. 1.2.2 must be observed

T-Connector aluminum

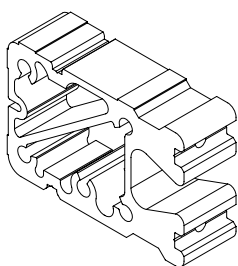

Item	Designation	Dimensions	System	PU	[..]
RHT5040-2	T-Connector for SR5040-2	45,4 x 35 x 25 mm (2)	50	1	pc.
RHT5090-2	T-Connector for SR5090-2	45,4 x 85 x 25 mm (4)	50	1	pc.
RHT50120-2	T-Connector for SR50120-2	45,4 x 115 x 25 mm (6)	50	1	pc..
RHT50150-3	T-Connector for SR50150-3	43,4 x 143 x 25 mm (6)	50	1	pc.
RHT6040-2	T-Connector for SR6040-2	55,4 x 35 x 25 mm (2)	60	1	pc.
RHT6060-2	T-Connector for SR6060-2	55,4 x 55 x 25 mm (4)	60	1	pc.
RHT6090-2	T-Connector for SR6090-2	55,4 x 85 x 25 mm (5)	60	1	pc.
RHT6090-4	T-Connector for SR6090-4	51,4 x 81 x 25 mm (5)	60	1	pc.
RHT60140-2	T-Connector for SR60140-2	55,4 x 135 x 25 mm (6)	60	1	pc.
RHT60140-4	T-Connector for SR60140-4	51,4 x 131 x 25 mm (6)	60	1	pc.
RHT60180-3	T-Connector for SR60180-3	53,4 x 173 x 25 mm (6)	60	1	pc.
RHT60180-5	T-Connector for SR60200-5	49,4 x 169 x 25 mm (6)	60	1	pc.

Scews

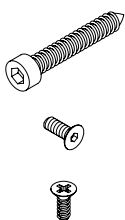

Item	Designation	Dimensions	PU	[..]
Z0118	Screw for T-Connector	6,3 x 40 mm	200	pc.
Z0128	Fixing screw transom	M6 x 18 mm	200	pc.
Z0120	Fixing screw transom	4,8 x 16 mm	100	pc.

the processing instructions & drilling patterns for the RHT in chap. 1.2.2 must be observed

Stabalux SR - Mullion-Transom-Connector

Transom holder steel (Fire protection)

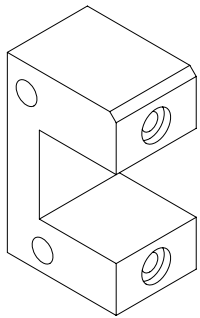

Item	Designation	Dimensions	System	PU	[..]
RHT9007	T-Connector for SR5040-2	44 x 34 x 25 mm (2)	50	1	pc.
RHT9008	T-Connector for SR6040-2 SR6060-2	54 x 34 x 25 mm (2)	60	1	pc.
RHT9027	T-Connector for SR5090-2 SR50120-2	44 x 74 x 25 mm (3)	50	1	pc.
RHT9023	T-Connector for SR6090-2	54 x 74 x 25 mm (3)	60	1	pc.
RHT9028	T-Connector for SR6090-2 SR60140-2	54 x 74 x 50 mm (3)	60	1	pc.
RHT9011	T-Connector for SR6090-4	50 x 74 x 25 mm (3)	60	1	pc.
RHT9015	T-Connector for SR50150-3	43 x 133 x 25 mm (3)	50	1	pc.
RHT9026	T-Connector for SR60130-3-D	52 x 37 x 25 mm (2)	60	1	pc.
RHT9014	T-Connector for SR60140-2	54 x 124 x 25 mm (3)	60	1	pc.
RHT9012	T-Connector for SR60140-4	50 x 124 x 25 mm (3)	60	1	pc.
RHT9025	T-Connector for SR60180-3	52 x 165 x 25 mm (3)	60	1	pc.
RHT9031	T-Connector for SR60180-3-T right	54 x 46 x 25 mm (4)	60	1	pc.
<i>RIGHT seen from the outside of the facade or the groove side</i>					
<i>for bolt SR6090-2 on SR60180-3-T; For screw connection, see chapter 1.2.2 of the catalog</i>					
RHT9032	Transom holder for SR60180-3-T left	54 x 46 x 25 mm (4)	60	1	pc.
<i>LEFT seen from the outside of the facade or the groove side</i>					
<i>for bolt SR6090-2 on SR60180-3-T; For screw connection, see chapter 1.2.2 of the catalog</i>					
RHT9013	Transom holder for SR60180-5 SR60200-5	48 x 164 x 25 mm (3)	60	1	pc.

Screws

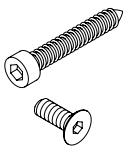

Item	Designation	Dimensions	PU	[..]
Z0146	Screw for transom holder	6,5 x 40 mm	100	pc.
Z0122	Fixing screw transom	M6 x 14 mm	100	pc.
<i>the processing instructions & drilling patterns for the RHT in chap. 1.2.2 must be observed</i>				

Adapter profile aluminum - Stabalux SR (for coupling / brackets / reinforcement) without frontal holes

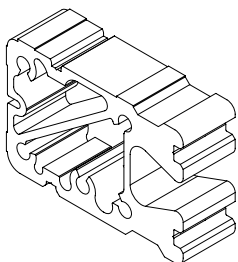

Item	Designation	Dimensions	System	PU	[..]
RHT5090-2-6000	Adapter profile for SR5090-2	45,4 x 85 x 6000 mm	50	1	m
RHT50120-2-6000	Adapter profile for SR50120-2	45,4 x 115 x 6000 mm	50	1	m
RHT50150-3-6000	Adapter profile for SR50150-3	43,4 x 143 x 6000 mm	50	1	m
RHT6090-2-6000	Adapter profile for SR6090-2	55,4 x 85 x 6000 mm	60	1	m
RHT6090-4-6000	Adapter profile for SR6090-4	51,4 x 81 x 6000 mm	60	1	m
RHT60140-2-6000	Adapter profile for SR60140-2	55,4 x 135 x 6000 mm	60	1	m
RHT60140-4-6000	Adapter profile for SR60140-4	51,4 x 131 x 6000 mm	60	1	m
RHT60180-3-6000	Adapter profile for SR60180-3	53,4 x 173 x 6000 mm	60	1	m
RHT60180-5-6000	Adapter profile for SR60200-5	49,4 x 169 x 6000 mm	60	1	m

Stabalux SR - Glass support

2-part glass supports up to max. 30 mm glass thickness
consisting of lower and upper part

Item	Designation	Dimension	PU	[..]
Lower part				
GH0260	Glass support lower part	Depth 8 mm	1	pc.
GH0261	Glass support lower part	Depth 10 mm	1	pc.
GH0262	Glass support lower part	Depth 20 mm	1	pc.

Upper part (depending on the glass thickness)

GH0263	Glass support upper part	Depth 10 mm	1	pc.
GH0264	Glass support upper part	Depth 20 mm	1	pc.
GH0265	Glass support upper part	Depth 22 mm	1	pc.
GH0266	Glass support upper part	Depth 24 mm	1	pc.
GH0267	Glass support upper part	Depth 26 mm	1	pc.
GH0268	Glass support upper part	Depth 30 mm	1	pc.

Screw connection of lower part in screw channel vertical glazing

Item	Designation	Dimension	PU	[..]
Without penetrating the wall				
Z0116	Screw for GH0260 GH0261	6,3 x 30 mm	200	pc.
Z0118	Screw for GH0262	6,3 x 40 mm	200	pc.

Screw connection lower part in screw channel sloping glazing

Item	Designation	Dimension	PU	[..]
Without penetrating the wall				
Z0249	Screw for GH0261	6,3 x 35 mm	200	pc.
Z0118	Screw for GH0262	6,3 x 40 mm	200	pc.
Z0119	Screw for GH0262	6,3 x 45 mm	200	pc.

Screwed glass support GH 5201 | GH 5202

Item	Designation	Dimension	PU	[..]
GH 5201	Glass support (3 Screw)	100 mm	1	Stk.
GH 5202	Glass support (6 Screw)	200 mm	1	Stk.

Screw connection

Item	Designation	Dimension	PU	[..]
Z0118	Screw for GH5201 GH 5202	6,3 x 40 mm	200	Stk.

Insert glass supports up to max. 58 mm glass thickness
Cut to glass thickness on site

Item	Designation	Dimension	PU	[..]
GH0281	Glass support	Lenght 100 mm	1	pc.
GH0282	Glass support	Lenght 150 mm	1	pc.

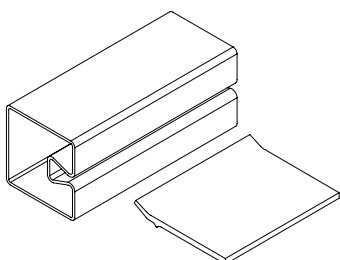
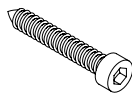
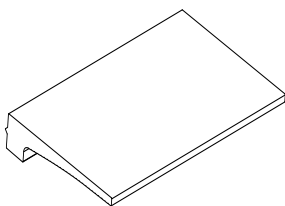
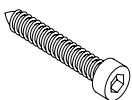
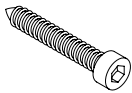
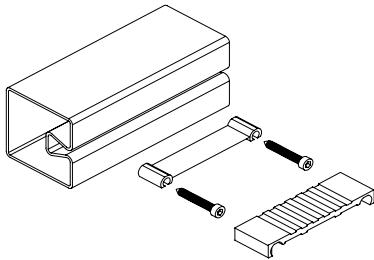

Stabalux SR - Inner gasket | Facade

Gasket | Height 5 mm | Butt joint

Item	Designation	System	PU	[..]
Mullion				
GD5201	Inner gasket 2 and 3 mm	50	25	m
GD6202	Inner gasket 2 and 3 mm	60	25	m
GD5201-G30	Inner gasket 2 and 3 mm Fire protection G30	50	25	m
GD6202-G30	Inner gasket 2 and 3 mm Fire protection G30	60	25	m
GD6202-F30	Inner gasket 2 and 3 mm Fire protection F30	60	25	m
GD6222	Inner gasket 4 and 5 mm	60	25	m
GD6222-G30	Inner gasket 4 and 5 mm Fire protection G30	60	25	m
GD6222-F30	Inner gasket 4 and 5 mm Fire protection F30	60	25	m
Transom				
GD5203	Inner gasket 2 and 3 mm	50	25	m
GD6204	Inner gasket 2 and 3 mm	60	25	m
GD5204	Inner gasket 2 and 3 mm (Glass > 50 mm)	50	25	m
GD6205	Inner gasket 2 and 3 mm (Glass > 50 mm)	60	25	m
GD5203-G30	Inner gasket 2 and 3 mm Fire protection G30	50	25	m
GD6204-G30	Inner gasket 2 and 3 mm Fire protection G30	60	25	m
GD6204-F30	Inner gasket 2 and 3 mm Fire protection F30	60	25	m
GD6224	Inner gasket 4 and 5 mm	60	25	m
GD6225	Inner gasket 4 and 5 mm (Glass > 50 mm)	60	25	m
GD6224-G30	Inner gasket 4 and 5 mm Fire protection G30	60	25	m
GD6224-F30	Inner gasket 4 and 5 mm Fire protection F30	60	25	m

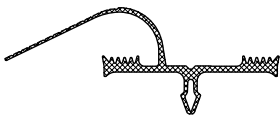
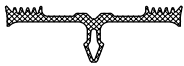

2-level gasket | Height 10 mm | overlapping

Item	Designation	System	PU	[..]
Mullion				
GD6206	Inner gasket 2 and 3 mm	60	25	m
GD6226	Inner gasket 4 and 5 mm	60	25	m
Transom				
GD6303	Inner gasket	60	25	m

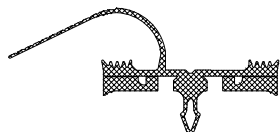
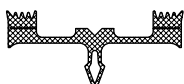

Stabalux SR - Inner gasket | Facade

3-level gasket | Height 12 mm | overlapping

Item	Designation	System	PU	[..]
Main mullion				
GD5314	Inner gasket 2 and 3 mm	50	25	m
GD6314	Inner gasket 2 and 3 mm	60	25	m
GD6324	Inner gasket 4 and 5 mm	60	25	m
Secondary mullion				
GD5315	Inner gasket 2 and 3 mm	50	25	m
GD6315	Inner gasket 2 and 3 mm	60	25	m
GD6325	Inner gasket 4 and 5 mm	60	25	m
Transom				
GD5317	Inner gasket 2 and 3 mm (Glas ≤ 50 mm)	50	25	m
GD6318	Inner gasket 2 and 3 mm	60	25	m
GD6328	Inner gasket 4 and 5 mm	60	25	m

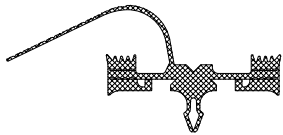
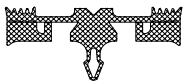
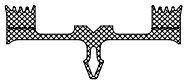

Polygonal glazing mullion

Item	Designation	System	PU	[..]
Outside corner with 3 to 15 °				
GD6210*	Inner gasket 2 and 3 mm	60	25	m
GD6212*	Inner gasket 4 and 5 mm	60	25	m
<i>* in connection with 2-part outer seal GD1925</i>				
Inside corner with 3 to 15 °				
GD6211**	Inner gasket 2 and 3 mm	60	25	m
GD6213**	Inner gasket 4 and 5 mm	60	25	m
<i>** in connection with 2-part outer seal GD1928</i>				

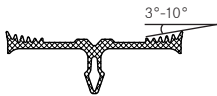
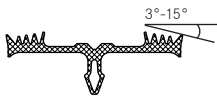

Stabalux SR - Inner gasket | Roof

Roof system up to 2 ° inclination | Height 10 mm | overlapping

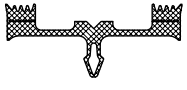
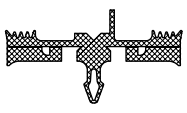
Item	Designation	System	PU	[..]
Mullion				
	GD5205	Inner gasket 2 and 3 mm	50	25 m
	GD6206	Inner gasket 2 and 3 mm	60	25 m
	GD6226	Inner gasket 4 and 5 mm	60	25 m
Transom				
	GD5207	Inner gasket 2 and 3 mm	50	25 m
	GD6208	Inner gasket 2 and 3 mm	60	25 m
	GD6228	Inner gasket 4 and 5 mm	60	25 m

Roof system up to 2 ° inclination | Height 14 mm | overlapping

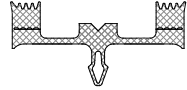
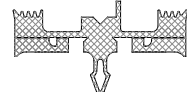
Item	Designation	System	PU	[..]
Mullion				
	GD6230	Inner gasket 4 and 5 mm	60	25 m
Transom				
	GD6231	Inner gasket 4 and 5 mm	60	25 m

Roof system fire protection from 15 ° to 80 ° inclination | Height 10 mm | overlapping

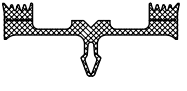
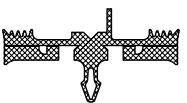
Item	Designation	System	PU	[..]
Mullion				
	GD6206-G30	Inner gasket 2 and 3 mm Fire protection G30	60	25 m
	GD6226-G30	Inner gasket 4 and 5 mm Fire protection G30	60	25 m
Transom				
	GD6208-G30	Inner gasket 2 and 3 mm Fire protection G30	60	25 m
	GD6228-G30	Inner gasket 4 and 5 mm Fire protection G30	60	25 m

Stabalux AK - System profile

Add-on channel aluminium

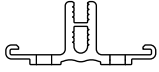

Item	Designation	PU	[..]
AK5010	Add-on channel brute Slot hole 5,4 x 7,2 mm every 200 mm	6	m
AK6010	Add-on channel brute Slot hole 5,4 x 7,2 mm every 200 mm	6	m

Mounting of the AK6010 / AK5010 on steel

different screw connection see processing notes chapter 3.1.1

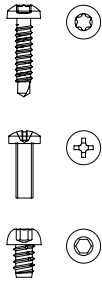

Item	Designation	Dimension	PU	[..]
Z0171	Screw for thickness 2,5 - 4 mm	4,8 x 22 mm bimetal	100	pc.
Z0172	Screw for thickness 2,5 - 6 mm	5,5 x 25 mm bimetal	200	pc.
Z0173	Screw for thickness 4-12 mm	5,5 x 40 mm bimetal	200	pc.
Z0174	Screw for thickness from 6 mm	M5 x 17 mm	100	pc.
Z0192	Screw for blind hole	6,3 x 9,5 mm	250	pc.

Add-on channel steel

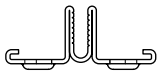

Item	Designation	PU	[..]
AK6020	Add-on channel galvaniced Slot hole 9,5 x 35 mm every 200 mm	6	m
AK6020s	Add-on channel blank Slot hole 9,5 x 35 mm every 200 mm	6	m

Mounting the AK6020 on steel

Welded joint see processing instructions „Welding instructions“

Stabalux AK - Glass support

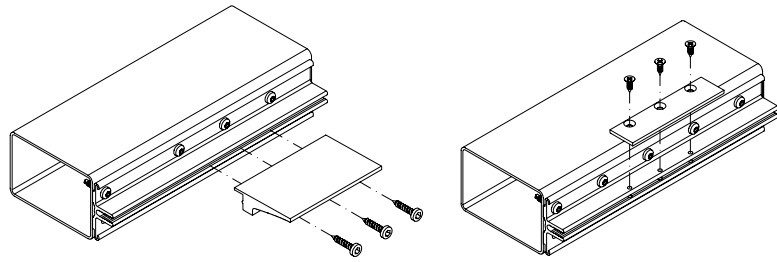

Glass support for Stabalux AK; till 60 mm glass thickness

Use according to glass thickness and weight see processing instructions

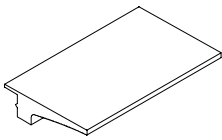

Item	Designation	Dimension	PU	[..]
GH6071	Glass support	61,5 x 100 mm	1	pc.
GH6072	Glass support	61,5 x 200 mm	1	pc.

Screw to fix glass support GH6071/GH6072

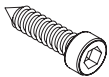

Item	Designation	Dimension	PU	[..]
Z0247	Cylinder head screw for GH	6,3 x 25 mm	200	pc.

Glass support for Stabalux AK; till 18 mm glasstickness

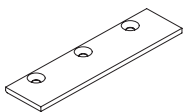

Item	Designation	Dimension	PU	[..]
GH6073	Glass support	flat - 25 x 100 mm	1	pc.

Screw to fix glass support GH6073



Item	Designation	Dimension	PU	[..]
Z0193	Screw for GH 6073	4,2 x 13 mm	100	pc.

Stabalux AK - Inner gasket | Facade

2-level gasket | height 16.5 mm | overlapping

Item	Designation	System	PU	[..]
Pfosten				
GD5071	Inner gasket	50	25	m
GD6071	Inner gasket	60	25	m
GD6075	Inner gasket Radius > 6mm	60	25	m
GD8071	Inner gasket	80	25	m
GD8077	Inner gasket Radius > 6mm	80	25	m
Riegel				
GD5072	Inner gasket	50	25	m
GD6072	Inner gasket	60	25	m
GD6076	Inner gasket Radius > 6mm	60	25	m
GD8072	Inner gasket	80	25	m
GD8076	Inner gasket Radius > 6mm	80	20	m
Sealing piece for transom end				
Z0062	Sealing piece EPDM (transom)	50, 60, 80	50	pc.

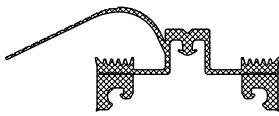

Polygonal glazing Mullion

Item	Designation	System	PU	[..]
Outside corner with 3 to 15°				
GD6074	Inner gasket	60	25	m

in conjunction with 2-part outer gasket GD1925

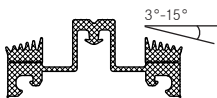

Stabalux AK - Inner gasket | Roof

2-level gasket | height 16.5 mm | overlapping

Item	Designation	System	PU	[..]
Mullion/rafter				
GD5071	Inner gasket	50	25	m
GD6071	Inner gasket	60	25	m
GD8071	Inner gasket	80	25	m
Transom				
GD5073	Inner gasket	50	25	m
GD6073	Inner gasket	60	25	m
GD8073	Inner gasket	80	25	m
Sealing piece for transom end				
Z0062	Sealing piece EPDM (transom)	50, 60, 80	50	pc.

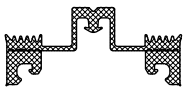
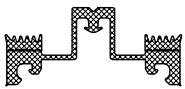

2-level gasket | height 22.5 mm | overlapping

Artikel	Bezeichnung	System	VE	[..]
Mullion/rafter				
GD6081	Inner gasket (Glass from 4mm)	60	25	m
Transom				
GD6083	Inner gasket (Glass from 4mm)	60	25	m

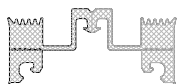
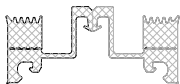

Stabalux - System screws

Stainless steel screw with cutting groove | sliding coated

Cylinder head screw \varnothing 10 mm | with hexagon socket | **with** sealing washer



Item	Designation	Dimension	PU	[..]
Z0148	Cylinder head screw	6,3 x 30 mm	200	pc.
Z0149	Cylinder head screw	6,3 x 35 mm	200	pc.
Z0151	Cylinder head screw	6,3 x 40 mm	200	pc.
Z0152	Cylinder head screw	6,3 x 45 mm	200	pc.
Z0153	Cylinder head screw	6,3 x 50 mm	200	pc.
Z0154	Cylinder head screw	6,3 x 55 mm	200	pc.
Z0155	Cylinder head screw	6,3 x 60 mm	200	pc.
Z0156	Cylinder head screw	6,3 x 65 mm	200	pc.
Z0157	Cylinder head screw	6,3 x 70 mm	200	pc.
Z0158	Cylinder head screw	6,3 x 75 mm	200	pc.
Z0161	Cylinder head screw	6,3 x 80 mm	200	pc.
Z0162	Cylinder head screw	6,3 x 85 mm	250	pc.
Z0163	Cylinder head screw	6,3 x 90 mm	200	pc.
Z0164	Cylinder head screw	6,3 x 95 mm	200	pc.
Z0165	Cylinder head screw	6,3 x 100 mm	250	pc.
Z0167	Cylinder head screw	6,3 x 110 mm	200	pc.
Z0166	Cylinder head screw	6,3 x 120 mm	200	pc.

Stainless steel screw with cutting groove | sliding coated

Cylinder head screw \varnothing 10 mm | with hexagon socket | **without** sealing washer

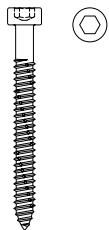

Item	Designation	Dimension	PU	[..]
Z0293	Cylinder head screw	6,3 x 18 mm	250	pc.
Z0247	Cylinder head screw	6,3 x 25 mm	200	pc.
Z0253	Cylinder head screw	6,3 x 50 mm	250	pc.
Z0255	Cylinder head screw	6,3 x 60 mm	200	pc.
Z0257	Cylinder head screw	6,3 x 70 mm	200	pc.
Z0258	Cylinder head screw	6,3 x 75 mm	200	pc.
Z0241	Cylinder head screw	6,3 x 80 mm	200	pc.
Z0242	Cylinder head screw	6,3 x 85 mm	200	pc.
Z0243	Cylinder head screw	6,3 x 90 mm	200	pc.
Z0033	PA washer	\varnothing 10 (6,3) x 1,5 mm	100	pc.



Stabalux T

T-profiles | hot rolled

Item	Designation	Dimension	kg/m	PU	[..]
System 50					
T5050-6000	T-profil S235 carbon	50/50 x 8,0 mm	5,9	6	m
T5080-6000	T-profil S235 carbon	50/80 x 8,0 mm	7,8	6	m
System 60					
T60180-R-4000	T-profil S235 carbon	60x10,0/180 x 8,0 mm round	21,4	4	m
T60180-R-8000	T-profil S235 carbon	60x10,0/180 x 8,0 mm round	21,4	8	m
T60180-R-12000	T-profil S235 carbon	60x10,0/180 x 8,0 mm round	21,4	12	m

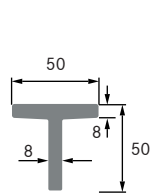

T5050

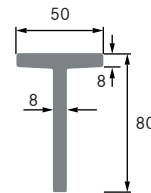

T5080

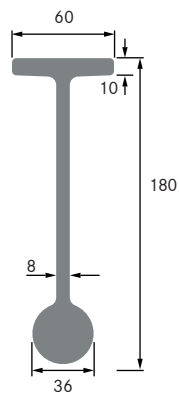

T60180-R

Stabalux ZL - System profile

Intermediate strip made of plastic

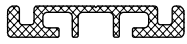

Item	Designation	Dimension	System	PU	[..]
ZL5053	Intermediate strip	50 x 10 / 6000 mm	50	6	m
ZL6053	Intermediate strip	60 x 10 / 6000 mm	60	6	m
ZL8053	Intermediate strip	80 x 10 / 6000 mm	80	6	m

Stabalux ZL - Inner gasket | Facade

Seal | Height 5 mm | Butt joint



Item	Designation	System	PU	[..]
Mullion				
GD5025	Inner gasket	50	25	m
GD6025	Inner gasket	60	25	m
GD8025	Inner gasket	80	25	m

Transom

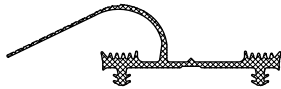

GD5030	Inner gasket	50	25	m
GD6030	Inner gasket	60	25	m
GD6032	Inner gasket (Glass > 50 mm)	60	25	m
GD8030	Inner gasket	80	25	m

2-level gasket | Height 10 mm | overlapping

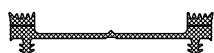

Item	Designation	System	PU	[..]
Mullion				
GD8033	Inner gasket	80	25	m

Transom

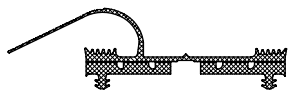

GD8031	Inner gasket	80	25	m
--------	--------------	----	----	---

Polygonal glazing Mullion



Item	Designation	System	PU	[..]
Outside corner 3 to 15°				
GD6038	Inner gasket	60	25	m
<i>in conjunction with 2-part outer gasket GD1925</i>				

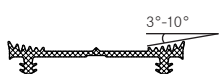

Inner corner 3 to 10°				
GD6036	Inner gasket	60	25	m
<i>in conjunction with 2-part outer gasket GD1928</i>				

Stabalux ZL - Inner gasket | Roof

Roof system up to 2° inclination | Height 10 mm | overlapping

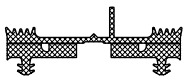

Item	Designation	System	PU	[..]
Mullion / rafter				
GD5033	Inner gasket	50	25	m
GD6033	Inner gasket	60	25	m
GD8033	Inner gasket	80	25	m
Transom				
GD5034	Inner gasket	50	25	m
GD6034	Inner gasket	60	25	m

Stabalux ZL - Screw connection

Screw nut



Item	Designation	Dimension	PU	[..]
Z0043	Screw nut stainless steel	M6	100	pc.
<i>in connection with OL6012 and OL6069 only to be used without sealing washer</i>				

Washer



Item	Designation	Dimension	PU	[..]
Z0046	Washer stainless steel	with 2 mm seal	100	pc.
Z0086	Washer stainless steel	with 4 mm seal	100	pc.

Threaded bolt



Item	Designation	Dimension	PU	[..]
Z0034	Threaded bolt stainless steel	M6 x 20 mm	100	pc.
Z0038	Threaded bolt stainless steel	M6 x 25 mm	100	pc.
Z0035	Threaded bolt stainless steel	M6 x 30 mm	100	pc.
Z0040	Threaded bolt stainless steel	M6 x 35 mm	100	pc.
Z0036	Threaded bolt stainless steel	M6 x 40 mm	100	pc.
Z0037	Threaded bolt stainless steel	M6 x 50 mm	100	pc.
Z0044	Threaded bolt stainless steel	M6 x 60 mm	100	pc.
Z0045	Threaded bolt stainless steel	M6 x 75 mm	100	pc.
Z0039	Threaded bolt stainless steel	M6 x 90 mm	100	pc.
Z0053	Threaded bolt stainless steel	M6 x 100 mm	100	pc.
Z0054	Threaded bolt stainless steel	M6 x 120 mm	100	pc.

Threaded socket

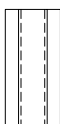

Item	Designation	Dimension	PU	[..]
Z0029	Threaded socket stainless steel	M6 x 25 mm	100	pc.
Z0032	Threaded socket plastic	M6 x 25 mm	100	pc.

Stabalux ZL - Glass support

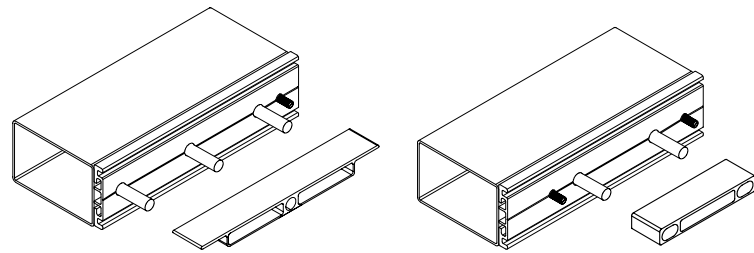

Glass support for bolts \varnothing 8 mm to max. 26 mm glass thickness

The use of the glass supports can be found in the processing instructions

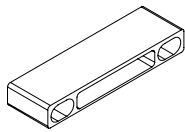

Item	Designation	Dimension	PU	[..]
GH0074	Glass support	Depth 24 mm	1	pc.
GH0075	Glass support	Depth 26 mm	1	pc.
GH0076	Glass support	Depth 28 mm	1	pc.

Glass support for bolts \varnothing 10 mm to max. 54 mm glass thickness

The use of the glass supports can be found in the processing instructions

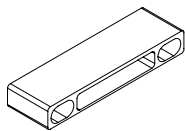

Item	Designation	Dimension	PU	[..]
GH0081	Glass support	Depth 9 mm	1	pc.
GH0082	Glass support	Depth 24 mm	1	pc.
GH0083	Glass support	Depth 26 mm	1	pc.
GH0084	Glass support	Depth 28 mm	1	pc.
GH0085	Glass support	Depth 30 mm	1	pc.
GH0086	Glass support	Depth 32 mm	1	pc.
GH0087	Glass support	Depth 35 mm	1	pc.
GH0088	Glass support	Depth 38 mm	1	pc.
GH0089	Glass support	Depth 41 mm	1	pc.
GH0090	Glass support	Depth 44 mm	1	pc.
GH0091	Glass support	Depth 47 mm	1	pc.
GH0092	Glass support	Depth 50 mm	1	pc.
GH0093	Glass support	Depth 53 mm	1	pc.
GH0094	Glass support	Depth 56 mm	1	pc.
GH5053	Glass support	Extrudes profil	6	m

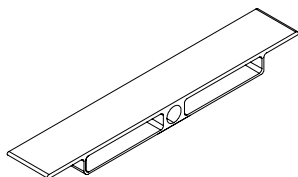

Item	Designation	Dimension	PU	[..]
GH0851	Glass support	Depth 26 mm	1	pc.
GH0852	Glass support	Depth 28 mm	1	pc.
GH0853	Glass support	Depth 30 mm	1	pc.
GH0854	Glass support	Depth 32 mm	1	pc.
GH0855	Glass support	Depth 35 mm	1	pc.
GH0856	Glass support	Depth 38 mm	1	pc.
GH0857	Glass support	Depth 41 mm	1	pc.
GH0858	Glass support	Depth 44 mm	1	pc.
GH0859	Glass support	Depth 47 mm	1	pc.
GH0860	Glass support	Depth 50 mm	1	pc.
GH0861	Glass support	Depth 53 mm	1	pc.
GH0862	Glass support	Depth 56 mm	1	pc.

Outer gasket | Facade

1-piece outer gasket

Item	Designation	System	PU	[..]
GD5024	Outer gasket	50	25	m
GD6024	Outer gasket	60	25	m
GD6024-G30	Outer gasket	Fire protection G30	60	25 m
GD6024-F30	Outer gasket	Fire protection F30	60	25 m
GD8024	Outer gasket	80	25	m
GD5054	Outer gasket	Transom	50	25 m
GD6054	Outer gasket	Transom	60	25 m
GD8054	Outer gasket	Transom	80	25 m



Outer gaskets for stainless steel bottom strips UL5110 | UL6110 | UL6110c

GD5122-G30	Outer gasket	Fire protection G30	50	25 m
GD6022-G30	Outer gasket	Fire protection G30	60	25 m
GD6022-F30	Outer gasket	Fire protection F30	60	25 m
GD5122-WK	Outer gasket	Burglar resistance RC2	50	25 m
GD6122-WK	Outer gasket	Burglar resistance RC2 RC3	60	25 m



2-piece outer gasket system 50 | 60 | 80 mm

Item	Designation	PU	[..]
GD1932	Outer gasket 2-piece 5 mm	25	m
GD1934	Outer gasket 2-piece 4 mm	25	m
GD1936	Outer gasket 2-piece 6 mm	25	m
GD1938	Outer gasket 2-piece 8 mm	25	m
GD1940	Outer gasket 2-piece 10 mm	25	m
GD1925	Outer gasket 2-piece for outside corner polygonal 3-15°	25	m
GD1928	Outer gasket 2-piece for inner corner polygonal 3-10°	25	m
GD6174	Outer gasket 2-piece Mullion DL5073 DL6073	25	m
GD6175	Outer gasket 2-piece Transom DL5073 DL6073	25	m

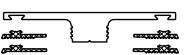
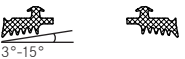

Outer gasket | Roof

1-piece outer gasket up to 2° inclination

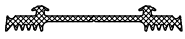

Item	Designation	System	PU	[..]
GD5024	Outer gasket	50	25	m
GD6024	Outer gasket	60	25	m
GD8024	Outer gasket	80	25	m

Stainless steel sealing plate

(for additional tightness in sloped glazing up to 10° inclination)

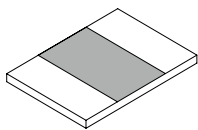

Item	Designation	Dimension	System	PU	[..]
Z0501	Stainless steel sealing plate	60 x 40 mm	50	10	pc.
Z0601	Stainless steel sealing plate	60 x 50 mm	60	10	pc.
Z0801	Stainless steel sealing plate	70 x 70 mm	80	10	pc.

1-piece outer gasket Fire protection from 15° up to 80° inclination



Item	Designation	System	PU	[..]
GD6024-G30	Outer gasket	Fire protection G30	60	25 m
GD6022-G30	Outer gasket	Fire protection G30	60	25 m

Hold-down clamp (roof system up to 2° incline)

With a roof pitch of up to 2°, there is no cover plate in the transom. In order to ensure that rainwater and dirt run off freely, the rebate is sealed with weather silicone. Hold-down devices are to be used to support the glass edges.

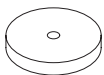

Item	Designation	Dimension	PU	[..]
Z0020	Hold-down stainless steel	round Height 8 mm	10	pc.
GD5009	Washer for Z0020	round 50 x 3 mm	50	pc.

Insulation block



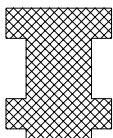

When sealing the rebate area of the bolt with weather silicone, insulation blocks can serve as backfill material.



Item	Designation	Dimension	PU	[..]
Z0610	Insulation block 20 / 5,2 (flat)	2.000 x 20 x 5,2 mm	50	m
Z0609	Insulation block 20 / 10,4 (T-form)	2.000 x 20 x 10,4 mm	50	m
Z0606	Insulation block 20 / 26	2.000 x 20 x 26 mm	50	m
Z0605	Insulation block 20 / 42	2.000 x 20 x 42 mm	50	m

Pressure plates with visible screw connections

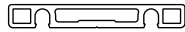
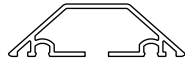
Pressure plates made of aluminum

Item	Designation	Dimension	System	PU	[..]	
	DL5067	Pressure plate blank	50 x 6 x 6000 mm	50	6	m
	DL6067	Pressure plate blank	60 x 6 x 6000 mm	60	6	m
	DL5071	Pressure plate blank	50 x 6 x 6000 mm	50	6	m
	DL6071	Pressure plate blank	60 x 6 x 6000 mm	60	6	m
	DL6071-ELO	Pressure plate E6EV1	60 x 6 x 6000 mm	60	6	m
	DL5059	Pressure plate blank	50 x 8 x 6000 mm	50	6	m
	DL6059	Pressure plate blank	60 x 8 x 6000 mm	60	6	m
	DL6059-ELO	Pressure plate E6EV1	60 x 8 x 6000 mm	60	6	m
	DL8059	Pressure plate blank	80 x 8 x 6000 mm	80	6	m
	DL5011	Pressure plate blank	50 x 18 x 6000 mm	50	6	m
	DL6011	Pressure plate blank	60 x 18 x 6000 mm	60	6	m
	DL5061	Pressure plate blank	50 x 25 x 6000 mm	50	6	m
	DL6061	Pressure plate blank	60 x 25 x 6000 mm	60	6	m
	DL6061-ELO	Pressure plate E6EV1	60 x 25 x 6000 mm	60	6	m

Pressure plates made of aluminum for SG-like glazing

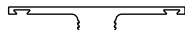
Item	Designation	Dimension	System	PU	[..]	
	DL5073	Flat pressure plate blank	50 x 2,5 / 6000 mm	50	6	m
	DL6073	Flat pressure plate blank	60 x 2,5 / 6000 mm	60	6	m

Cover plug for flat pressure plate DL5073 | DL6073

Item	Designation	PU	[..]		
	Z0089	Cover plug	for DL5073 DL6073	250	pc.

Stainless steel pressure plate

Upper profile 1.4571 | Sub-profile 1.4301 | sanded grain 240 | one-sided foil

Item	Designation	Dimension	System	PU	[..]	
	DL6044	Stainless steel pressure plate	60 x 20 / 6000 mm	60	6*	m
		<i>Lower profile perforated Ø7 mm every 125 mm</i>				

*Usable length = 5990 mm

Stainless steel pressure plates

Flat cover strip 1.4301 | 2 B

Item	Designation	Dimension	System	PU	[..]	
	DL6018	Stainless steel pressure plate	59 x 3 / 6000 mm	60	6	m

Pressure plates with concealed screw connections

Stainless steel cover plate

1.4401 | ground grit 220 | one-sided foil

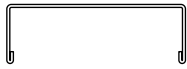

Item	Designation	Dimension	System	PU	[..]
OL6064	Stainless steel cover plate	60 x 20 / 6000 mm	60	6	m

Aluminum pressure plate for OL6064



UL6007-L ¹⁾	Pressure plate	57 x 6000 mm	60	6	m
------------------------	----------------	--------------	----	---	---

Pressure plates made of aluminium



Item	Designation	Dimension	System	PU	[..]
UL5009	Pressure plate	46 x 6000 mm	50	6	m
UL5009-L ¹⁾	Pressure plate	46 x 6000 mm	50	6	m
UL6009	Pressure plate	54,2 x 6000 mm	60	6	m
UL6009-L ¹⁾	Pressure plate	54,2 x 6000 mm	60	6	m
UL8009-L ¹⁾	Pressure plate	76 x 6000 mm	80	6	m

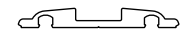

UL6005-L ¹⁾	Pressure plate	56 x 6000 mm	60	6	m
------------------------	----------------	--------------	----	---	---

Only for OL6066

Special screw cylinder head with hexagon socket without sealing washer e.g. Z0253, Z0254

¹⁾ Long hole 7 x 10 mm every 125 mm

Stainless steel pressure plates

1.4301

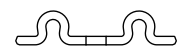

Item	Designation	Dimension	System	PU	[..]
UL5110 ^{2) 3)}	Stainless steel pressure plates	46 x 6000 mm	50	6 ⁵⁾	m
<i>for fire protection G30 for burglar resistance RC2</i>					
UL6110 ^{2) 4)}	Stainless steel pressure plates	56 x 6000 mm	60	6 ⁵⁾	m
UL6110c ^{2) 4)}	Galvanized pressure plates	56 x 6000 mm	60	6 ⁵⁾	m

for fire protection G30 / F30 | for burglar resistance RC2

²⁾ Long hole 7 x 10 mm every 250 mm;







³⁾ for GD5122-WK;

⁴⁾ for GD6022-G30/F30 & GD6122-WK ;

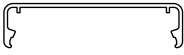
⁵⁾ Useful length = 5990 mm

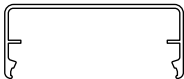
Cover plates with concealed screw connections

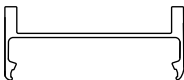
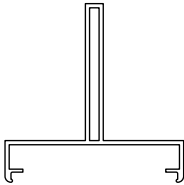
Cover plates made of aluminum

Item	Designation	Dimension	PU	[..]
	OL5025	Cover plate blank	50 x 15 / 6000 mm; Radius 0,5	6 m
	OL6011	Cover plate blank	60 x 13 / 6000 mm	6 m
	<i>only use with screw (e.g. Z0249) and separate sealing washer Z0033!</i>			
	OL5012	Cover plate blank	50 x 15 / 6000 mm	6 m
	OL6012	Cover plate blank	60 x 15 / 6000 mm	6 m
	OL6012-ELO	Cover plate E6EV1	60 x 15 / 6000 mm	6 m
	OL8012	Cover plate blank	80 x 15 / 6000 mm	6 m
	OL5013	Cover plate blank	50 x 18 / 6000 mm	6 m
	OL6013	Cover plate blank	60 x 18 / 6000 mm	6 m
	OL6013-ELO	Cover plate E6EV1	60 x 18 / 6000 mm	6 m
	OL8013	Cover plate blank	80 x 18 / 6000 mm	6 m
	OL5014	Cover plate blank	50 x 25 / 6000 mm	6 m
	OL6014	Cover plate blank	60 x 25 / 6000 mm	6 m
	OL6014-ELO	Cover plate E6EV1	60 x 25 / 6000 mm	6 m
	OL8014	Cover plate blank	80 x 25 / 6000 mm	6 m
	OL5015	Cover plate blank	50 x 47 / 6000 mm	6 m
	OL6015	Cover plate blank	60 x 50 / 6000 mm	6 m
	OL8015	Cover plate blank	80 x 50 / 6000 mm	6 m
	OL6081	Cover plate blank	60 x 150 / 6700 mm	6,7 m
	OL5016	Cover plate blank	50 x 25 / 6000 mm	6 m
	OL6016	Cover plate blank	60 x 25 / 6000 mm	6 m
	OL6069	Cover plate blank	60 x 14 (60) / 6000 mm	6 m
				
	OL6066	Cover plate blank	60 x 12,3 / 6000 mm	6 m
				
	<i>Only use with UL6005!</i>			

Stabalux fire protection

Fire protection glasses

We deliver fire protection glass within the scope of our current approvals (Pyran S and ISO-Pyran S, Pyroswiss and Pyrostop)

Nameplates for fire protection glazing

Item	Designation		PU	[..]
Z1235	Nameplate G30 roof	Approval Z-19.14-1235	1	pc.
Z1451	Nameplate F30 Facade	Approval Z-19.14-1451	1	pc.

Foil, fire protection quality for G30 | facade

Item	Designation	Dimension	PU	[..]
Z0059	Waterproofing membrane BS <i>(one side smooth, other side 5 mm subdivision)</i>	330 x 1 mm	25	m
Z0068	EPDM sealing strip	250 x 0,75 mm	25	m

G30 and F30 gaskets for T-profile

Gaskets are fixed **DIRECTLY** on the T-profile | no add-on system can be used

Item	Designation	System	PU	[..]
Facade mullion / transom				
GD6026-F30	Inner gasket Fire protection F30	60	25	m
Z0014	Bar flag for glass thickness 10 to 19 mm		25	m
Z0012	Bar flag for glass thickness 20 bis 38 mm		25	m
Z0013	Bar flag for glass thickness 39 bis 55 mm		25	m

Roof posts / rafters

GD6216-G30	Inner gasket Fire protection G30	60	25	m
------------	------------------------------------	-----------	----	---

Roof transom

GD6218-G30	Inner gasket Fire protection G30	60	25	m
------------	------------------------------------	-----------	----	---

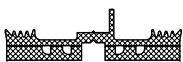

Stabalux equipment

Tools & accessories for seals

Item	Designation		PU	[..]
Z0056	Scissor		1	pc.
Z0077	Notching pliers	System 50	1	pc.
Z0078	Notching pliers	System 60	1	pc.
Z0060	Rolling tool	for bar flag (e.g. Z0012)	1	pc.
Z0069	Stabalux silikon spray	400 ml colorless	1	pc.
Z0094	Stabalux connection paste	310 ml black	1	pc.
<i>1 box = 12 pieces</i>				

Burglar resistance accessories

Item	Designation		PU	[..]
Z1061	Blocking (side) 20x24	for RC2 RC3	6	m
Z0093	Screw locking	Stainless steel ball; Ø 5.0 mm	100	pc.
<i>for screw locking RC2 and RC3; Bonding e.g. with Z0055</i>				

Cross bars for end fields

Item	Designation	Dimension	PU	[..]
Z1061	Rigid PVC cross bars; Gray	6000 x 20 x 24 mm	6	m
Z1062	Rigid PVC cross bars; Gray	6000 x 22 x 26 mm	6	m
Z1063	Rigid PVC cross bars; Gray	6000 x 28 x 30 mm	6	m
Z1064	Rigid PVC cross bars; Gray	6000 x 32 x 34 mm	6	m
Z1065	Rigid PVC cross bars; Gray	6000 x 36 x 38 mm	6	m
Z1066	Rigid PVC cross bars; Gray	6000 x 40 x 42 mm	6	m

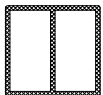

Insulation blocks for the glass rebate area

with permanent HOT-MELT; insert with split seal

Item	Designation	Dimension	PU	[..]
Rebate width 20 mm				
Z0606	Insulation block 20 / 26	2000 x 20 x 26 mm	50	m
Z0605	Insulation block 20 / 42	2000 x 20 x 42 mm	50	m
Rebate width 30 mm				
Z0608	Insulation block 30 / 26	2000 x 30 x 26 mm	50	m
Z0607	Insulation block 30 / 42	2000 x 30 x 42 mm	50	m

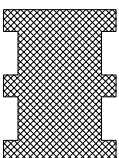

Gaskets | System-independent for steel profiles

Gaskets without radius

Item	Designation	System	PU	[..]
	GD5940 Gasket Height 5 mm	50	25	m
	GD6940 Gasket Height 5 mm	60	25	m
	GD6940-G30 Gasket Height 5 mm Brandschutz G30	60	25	m
	GD6026-G30 Gasket Height 5 mm Pfosten/Riegel	60	25	m
	Z0014 Bar flag for glass thickness 10 bis 19 mm		25	m
	Z0012 Bar flag for glass thickness 20 bis 38 mm		25	m
	Z0013 Bar flag for glass thickness 39 bis 55 mm		25	m
	GD0030 Gasket for 2 mm connection plates		25	m
	GD0035 Gasket self-adhesive 14 x 5 mm		100	m
	SG990011GD Inner gasket 3 mm	60	25	m
	SG990002GD Inner gasket 3 mm	45	25	m
	SG990001GD Inner gasket 3 mm	50	25	m

Gaskets with radius 3 mm

	GD5915-SK Gasket self-adhesive	50	25	m
	GD6916-SK Gasket self-adhesive	60	25	m



Gaskets with radius 8 mm

	GD5921 Inner gasket	50	25	m
	GD5921-SK Gasket self-adhesive	50	25	m

Gaskets with radius 12 mm

	GD5925 Inner gasket	50	25	m
---	---------------------	----	----	---

Gasket sloping glazing with a radius of 3 mm

Item	Designation	System	PU	[..]
Mullion				
	GD6946 Inner gasket	60	25	m
Transom				
	GD5901 Inner gasket	50	25	m
	GD6902 Inner gasket	60	25	m