



## General informations

### Item information

For individual items, the dimensions can be read from the item number.

- Gaskets – GD5201-G30 | Width 50 mm / Fire protection G30
- Cover and pressure plates – DL6067-ELO | Width 60 mm / anodized

Articles with article numbers beginning with 50 are for systems with a width of 50 mm, article numbers beginning with 60 are for systems with a width of 60 mm.

### Articel availability

Normally all items listed with a price are in stock and can be delivered immediately.

### Packing units [PU]

- Gaskets (GD) 25 m in a box (unless otherwise specified)
- Screws and bolts, depending on the version, 100 pieces or 200 pieces in a box
- Tubes, profiles and bar stock per specified storage length
- Special accessories, tools and various small items per version 1 pc. or 10 pc.

Order quantities that differ from the packaging units [PU] are confirmed and delivered in the next higher PU.

With surface-processed cover strips, the usable length is reduced by approx. 50 mm at the profile ends.

Special lengths for bar goods (screw tubes, T-profiles, top, cover and bottom strips) on request.

The technical drawings shown in the price list are not to scale. For technical details, see product information.

**We do not accept any liability for errors or misprints.**

### Order

Please fax or email your order to our order processing department:

Fax: **+49 228 909043-11**  
Mail: **c.service@stabalux.com**

### Stabalux GmbH

Fraunhoferstraße 8  
53121 Bonn - Germany  
Phone +49 228 909043-0

## Stabalux SR - Threaded tubes | Sendzimir-galvanized and stainless steel

Item	Designation	Dimensions	kg/m	PU	[..]
<b>System 50</b>					
SR5040-2-6000	SR tube   S280   galvanized	50x40x2   6000 mm	3,4	6	m
SR5090-2-6000	SR tube   S280   galvanized	50x90x2   6000 mm	5,0	6	m
SR50120-2-8000	SR tube   S280   galvanized	50x120x2   8000 mm	5,9	8	m
SR50150-3-7500	SR tube   S280   galvanized	50x150x3   7500 mm	10,3	7,5	m
<b>System 60</b>					
SR6040-2-6000	SR tube   S280   galvanized	60x40x2   6000 mm	3,7	6	m
SR6060-2-6000	SR tube   S280   galvanized	60x60x2   6000 mm	4,4	6	m
SR6090-2-6000	SR tube   S280   galvanized	60x90x2   6000 mm	5,3	6	m
SR6090-2-10000	SR tube   S280   galvanized	60x90x2   10000 mm	5,3	10	m
SR6090-4-8000	SR tube   S280   galvanized	60x90x4   8000 mm	10,0	8	m
SR60130-3-D-8000	SR tube   S280   galvanized	60x130x3   8000 mm	8,8	8	m
SR60140-2-6000	SR tube   S280   galvanized	60x140x2   6000 mm	6,9	6	m
SR60140-2-10000	SR tube   S280   galvanized	60x140x2   10000 mm	6,9	10	m
SR60140-4-8000	SR tube   S280   galvanized	60x140x4   8000 mm	13,2	8	m
SR60180-3-9000	SR tube   S280   galvanized	60x180x3   9000 mm	12,2	9	m
SR60200-5-10000	SR tube   S280   galvanized	60x200x5   10000 mm	21,1	10	m
AL9090	AL tube   corner profile	90x90   6000 mm	3,5	6	m

*Special lengths that can be produced within the production cycle are supplied at no extra charge.*

*Dates have to be agreed.*

## Stabalux SR - End caps

## Caps for screw tubes

*(made of 2 mm galvanized sheet steel)*

Item	Designation	Dimensions	PU	[..]
Z5045	Cap	for SR5040-2	10	pc.
Z5046	Cap	for SR5090-2	10	pc.
Z5047	Cap	for SR50150-3	10	pc.
Z6046	Cap	for SR6040-2	10	pc.
Z6101	Cap	for SR6060-2	10	pc.
Z6047	Cap	for SR6090-2	10	pc.
Z6050	Cap	for SR6090-4	10	pc.
Z6048	Cap	for SR60140-2	10	pc.
Z6051	Cap	for SR60140-4	10	pc.
Z6056	Cap	for SR60180-3	10	pc.



Stabalux SR - Threaded tubes | Sendzimir-galvanized and stainless steel

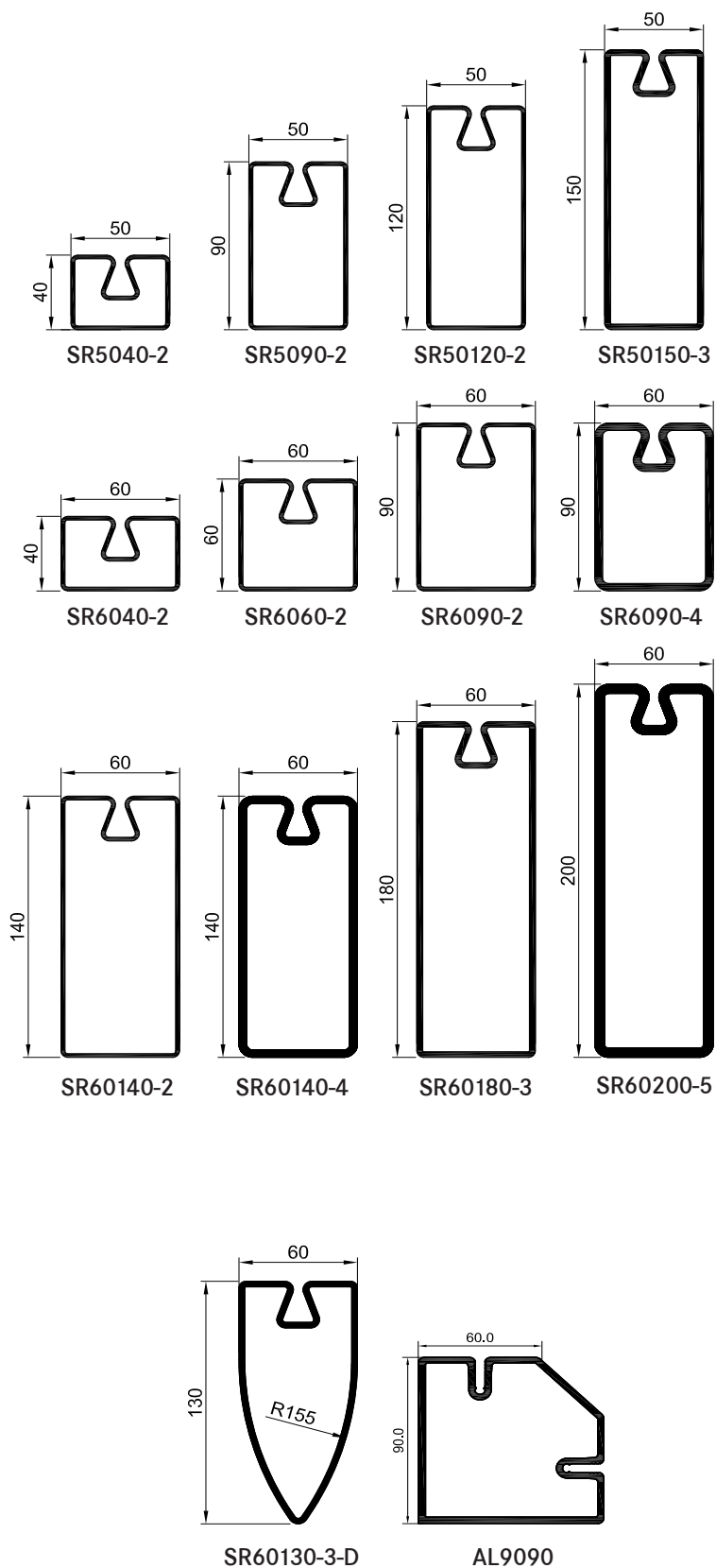

## Stabalux SR - Mullion-Transom-Connector

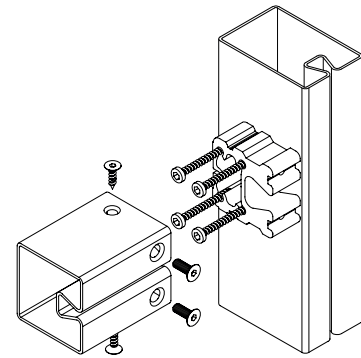

### T-Connector aluminum (for max. 2 mm wall thickness in the transom)

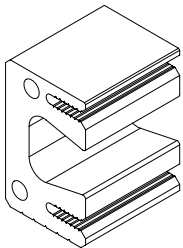

Item	Designation	Dimensions (screws)	System	PU	[..]
RHT9009	T-Connector	44 x 34 x 40 mm (2)	50	1	pc.
RHT9010	T-Connector	54 x 34 x 40 mm (2)	60	1	pc.
RHT9109	T-Connector (polygonal)	44 x 34 x 60 mm (2)	50	1	pc.
RHT9110	T-Connector (polygonal)	54 x 34 x 60 mm (2)	60	1	pc.

### Screws



Item	Designation	Dimensions	PU	[..]
Z0147	Screw for T-Connector	6,5 x 55 mm	100	pc.
Z0120	Fixing screw transom	4,8 x 16 mm	100	pc.

*the processing instructions & drilling patterns for the RHT in chap. 1.2.2 must be observed*

### T-Connector aluminum

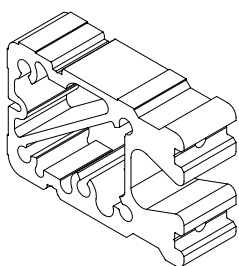

Item	Designation	Dimensions (screws)	System	PU	[..]
RHT5040-2	T-Connector for SR5040-2	45,4 x 35 x 25 mm (2)	50	1	pc.
RHT5090-2	T-Connector for SR5090-2	45,4 x 85 x 25 mm (4)	50	1	pc.
RHT50120-2	T-Connector for SR50120-2	45,4 x 115 x 25 mm (6)	50	1	pc..
RHT50150-3	T-Connector for SR50150-3	43,4 x 143 x 25 mm (6)	50	1	pc.
RHT6040-2	T-Connector for SR6040-2	55,4 x 35 x 25 mm (2)	60	1	pc.
RHT6060-2	T-Connector for SR6060-2	55,4 x 55 x 25 mm (4)	60	1	pc.
RHT6090-2	T-Connector for SR6090-2	55,4 x 85 x 25 mm (5)	60	1	pc.
RHT6090-4	T-Connector for SR6090-4	51,4 x 81 x 25 mm (5)	60	1	pc.
RHT60140-2	T-Connector for SR60140-2	55,4 x 135 x 25 mm (6)	60	1	pc.
RHT60140-4	T-Connector for SR60140-4	51,4 x 131 x 25 mm (6)	60	1	pc.
RHT60180-3	T-Connector for SR60180-3	53,4 x 173 x 25 mm (6)	60	1	pc.
RHT60180-5	T-Connector for SR60200-5	49,4 x 169 x 25 mm (6)	60	1	pc.

### Scews

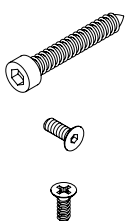

Item	Designation	Dimensions	PU	[..]
Z0118	Screw for T-Connector	6,3 x 40 mm	200	pc.
Z0128	Fixing screw transom	M6 x 18 mm	200	pc.
Z0120	Fixing screw transom	4,8 x 16 mm	100	pc.

*the processing instructions & drilling patterns for the RHT in chap. 1.2.2 must be observed*

## Stabalux SR - Mullion-Transom-Connector

### Transom holder steel (fire protection)

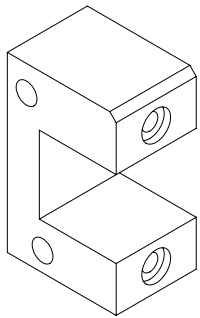

Item	Designation	Dimensions	System	PU	[..]
RHT9007	T-Connector for SR5040-2	44 x 34 x 25 mm (2)	50	1	pc.
RHT9008	T-Connector for SR6040-2   SR6060-2	54 x 34 x 25 mm (2)	60	1	pc.
RHT9027	T-Connector for SR5090-2   SR50120-2	44 x 74 x 25 mm (3)	50	1	pc.
RHT9023	T-Connector for SR6090-2	54 x 74 x 25 mm (3)	60	1	pc.
RHT9028	T-Connector for SR6090-2   SR60140-2	54 x 74 x 50 mm (3)	60	1	pc.
RHT9011	T-Connector for SR6090-4	50 x 74 x 25 mm (3)	60	1	pc.
RHT9015	T-Connector for SR50150-3	43 x 133 x 25 mm (3)	50	1	pc.
RHT9026	T-Connector for SR60130-3-D	52 x 37 x 25 mm (2)	60	1	pc.
RHT9014	T-Connector for SR60140-2	54 x 124 x 25 mm (3)	60	1	pc.
RHT9012	T-Connector for SR60140-4	50 x 124 x 25 mm (3)	60	1	pc.
RHT9025	T-Connector for SR60180-3	52 x 165 x 25 mm (3)	60	1	pc.
RHT9031	T-Connector for SR60180-3-T   right	54 x 46 x 25 mm (4)	60	1	pc.
<i>RIGHT seen from the outside of the facade or the groove side</i>					
<i>for bolt SR6090-2 on SR60180-3-T; For screw connection, see chapter 1.2.2 of the catalog</i>					
RHT9032	Transom holder for SR60180-3-T   left	54 x 46 x 25 mm (4)	60	1	pc.
<i>LEFT seen from the outside of the facade or the groove side</i>					
<i>for bolt SR6090-2 on SR60180-3-T; For screw connection, see chapter 1.2.2 of the catalog</i>					
RHT9013	Transom holder for SR60180-5   SR60200-5	48 x 164 x 25 mm (3)	60	1	pc.

### Screws

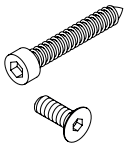

Item	Designation	Dimensions	PU	[..]
Z0146	Screw for transom holder	6,5 x 40 mm	100	pc.
Z0122	Fixing screw transom	M6 x 14 mm	100	pc.
<i>the processing instructions &amp; drilling patterns for the RHT in chapter 1.2.2 must be observed</i>				

### Adapter profile aluminum - Stabalux SR (for coupling / brackets / reinforcement) without frontal holes

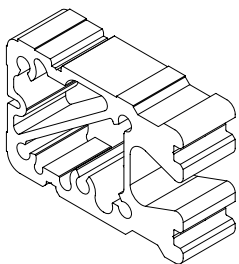

Item	Designation	Dimensions	System	PU	[..]
RHT5090-2-6000	Adapter profile for SR5090-2	45,4 x 85 x 6000 mm	50	1	m
RHT50120-2-6000	Adapter profile for SR50120-2	45,4 x 115 x 6000 mm	50	1	m
RHT50150-3-6000	Adapter profile for SR50150-3	43,4 x 143 x 6000 mm	50	1	m
RHT6090-2-6000	Adapter profile for SR6090-2	55,4 x 85 x 6000 mm	60	1	m
RHT6090-4-6000	Adapter profile for SR6090-4	51,4 x 81 x 6000 mm	60	1	m
RHT60140-2-6000	Adapter profile for SR60140-2	55,4 x 135 x 6000 mm	60	1	m
RHT60140-4-6000	Adapter profile for SR60140-4	51,4 x 131 x 6000 mm	60	1	m
RHT60180-3-6000	Adapter profile for SR60180-3	53,4 x 173 x 6000 mm	60	1	m
RHT60180-5-6000	Adapter profile for SR60200-5	49,4 x 169 x 6000 mm	60	1	m

## Stabalux SR - Glass support

### 2-part glass supports up to max. 30 mm glass thickness consisting of lower and upper part

Item	Designation	Dimensions	PU	[..]
<b>Lower part   Width 90 mm</b>				
GH0260	Glass support lower part	Depth 8 mm	1	pc.
GH0261	Glass support lower part	Depth 10 mm	1	pc.
GH0262	Glass support lower part	Depth 20 mm	1	pc.
<b>Upper part (depending on the glass thickness)   Width 95 mm</b>				
GH0263	Glass support upper part	Depth 10 mm	1	pc.
GH0264	Glass support upper part	Depth 20 mm	1	pc.
GH0265	Glass support upper part	Depth 22 mm	1	pc.
GH0266	Glass support upper part	Depth 24 mm	1	pc.
GH0267	Glass support upper part	Depth 26 mm	1	pc.
GH0268	Glass support upper part	Depth 30 mm	1	pc.

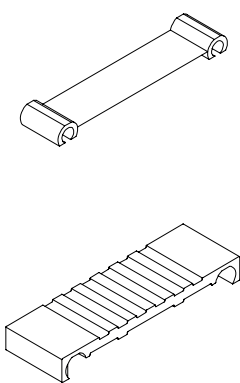

### Screw connection of lower part in screw channel vertical glazing

Item	Designation	Dimensions	PU	[..]
<b>Without penetrating the wall</b>				
Z0116	Screw for GH0260   GH0261	6,3 x 30 mm	200	pc.
Z0118	Screw for GH0262	6,3 x 40 mm	200	pc.

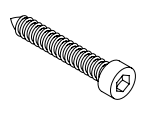

### Screw connection lower part in screw channel sloping glazing

Item	Designation	Dimensions	PU	[..]
<b>Without penetrating the wall</b>				
Z0249	Screw for GH0261	6,3 x 35 mm	200	pc.
Z0118	Screw for GH0262	6,3 x 40 mm	200	pc.
Z0119	Screw for GH0262	6,3 x 45 mm	200	pc.

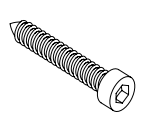

### Screwed glass support GH 5201 | GH 5202 up to max. 64 mm glass thickness Cut to glass thickness on site

Item	Designation	Width x depth	PU	[..]
GH 5201	Glass support (3 Screw)	100 mm x 65 mm	1	Stk.
GH 5202	Glass support (6 Screw)	200 mm x 65 mm	1	Stk.

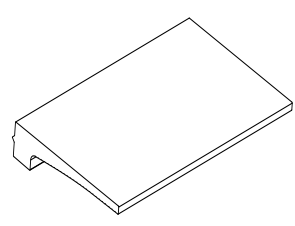

### Screw connection

Item	Designation	Dimensions	PU	[..]
Z0118	Screw for GH5201   GH 5202	6,3 x 40 mm	200	Stk.

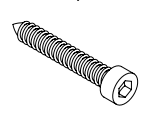

### Insert glass supports up to max. 58 mm glass thickness Cut to glass thickness on site

Item	Designation	Width x depth	PU	[..]
GH0281	Glass support	100 mm x 78,5 mm	1	pc.
GH0282	Glass support	150 mm x 78,5 mm	1	pc.

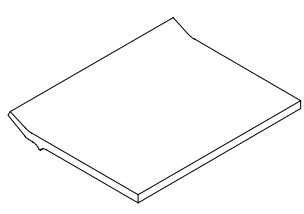

## Stabalux SR - Inner gasket | Facade

### Gasket | height 5 mm | butt joint

Item	Designation	System	PU	[..]
<b>Mullion</b>				
GD5201	Inner gasket   2 and 3 mm	50	25	m
GD6202	Inner gasket   2 and 3 mm	60	25	m
GD5201-G30	Inner gasket   2 and 3 mm   Fire protection G30	50	25	m
GD6202-G30	Inner gasket   2 and 3 mm   Fire protection G30	60	25	m
GD6202-F30	Inner gasket   2 and 3 mm   Fire protection F30	60	25	m
GD6222	Inner gasket   4 and 5 mm	60	25	m
GD6222-G30	Inner gasket   4 and 5 mm   Fire protection G30	60	25	m
GD6222-F30	Inner gasket   4 and 5 mm   Fire protection F30	60	25	m

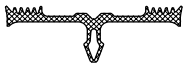

### Transom

GD5203	Inner gasket   2 and 3 mm	50	25	m
GD6204	Inner gasket   2 and 3 mm	60	25	m
GD5204	Inner gasket   2 and 3 mm   (Glass > 50 mm)	50	25	m
GD6205	Inner gasket   2 and 3 mm   (Glass > 50 mm)	60	25	m
GD5203-G30	Inner gasket   2 and 3 mm   Fire protection G30	50	25	m
GD6204-G30	Inner gasket   2 and 3 mm   Fire protection G30	60	25	m
GD6204-F30	Inner gasket   2 and 3 mm   Fire protection F30	60	25	m
GD6224	Inner gasket   4 and 5 mm	60	25	m
GD6225	Inner gasket   4 and 5 mm   (Glass > 50 mm)	60	25	m
GD6224-G30	Inner gasket   4 and 5 mm   Fire protection G30	60	25	m
GD6224-F30	Inner gasket   4 and 5 mm   Fire protection F30	60	25	m

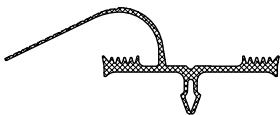

### 2-level gasket | height 10 mm | overlapping

Item	Designation	System	PU	[..]
<b>Mullion</b>				
GD6206	Inner gasket   2 and 3 mm	60	25	m
GD6226	Inner gasket   4 and 5 mm	60	25	m
<b>Transom</b>				
GD6303	Inner gasket	60	25	m

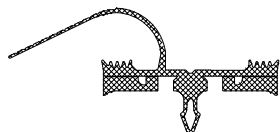
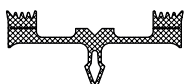



## Stabalux SR - Inner gasket | Facade

### 3-level gasket | height 12 mm | overlapping

Item	Designation	System	PU	[..]
<b>Main mullion</b>				
GD5314	Inner gasket   2 and 3 mm	50	25	m
GD6314	Inner gasket   2 and 3 mm	60	25	m
GD6324	Inner gasket   4 and 5 mm	60	25	m

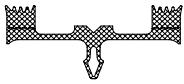

<b>Secondary mullion</b>				
GD5315	Inner gasket   2 and 3 mm	50	25	m
GD6315	Inner gasket   2 and 3 mm	60	25	m
GD6325	Inner gasket   4 and 5 mm	60	25	m

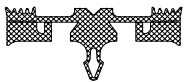

<b>Transom</b>				
GD5317	Inner gasket   2 and 3 mm   (Glass ≤ 50 mm)	50	25	m
GD6318	Inner gasket   2 and 3 mm	60	25	m
GD6328	Inner gasket   4 and 5 mm	60	25	m

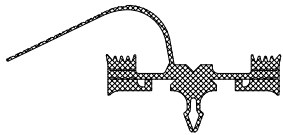

### Polygonal glazing mullion

Item	Designation	System	PU	[..]
<b>Outside corner with 3° to 15 °</b>				
GD6210*	Inner gasket   2 and 3 mm	60	25	m
GD6212*	Inner gasket   4 and 5 mm	60	25	m

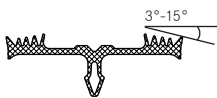

\* in connection with 2-part outer seal GD1925

<b>Inside corner with 3° to 15 °</b>				
GD6211**	Inner gasket   2 and 3 mm	60	25	m
GD6213**	Inner gasket   4 and 5 mm	60	25	m

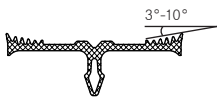

\*\* in combination with 2-part outer seal GD1928

## Stabalux SR - Inner gasket | Roof

### Roof system | height 10 mm | overlapping

Item	Designation	System	PU	[..]
<b>Mullion</b>				
GD5205	Inner gasket   2 and 3 mm	50	25	m
GD6206	Inner gasket   2 and 3 mm	60	25	m
GD6226	Inner gasket   4 and 5 mm	60	25	m
<b>Transom</b>				
GD5207	Inner gasket   2 and 3 mm	50	25	m
GD6208	Inner gasket   2 and 3 mm	60	25	m
GD6228	Inner gasket   4 and 5 mm	60	25	m

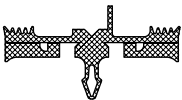
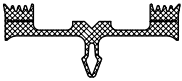

### Roof system | height 14 mm | overlapping

Item	Designation	System	PU	[..]
<b>Mullion</b>				
GD6230	Inner gasket   2 and 3 mm	60	25	m
<b>Transom</b>				
GD6231	Inner gasket   2 and 3 mm	60	25	m

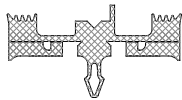
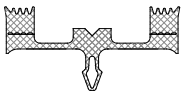

### Roof system fire protection from 15 ° to 80 ° inclination | height 10 mm | overlapping

Item	Designation	System	PU	[..]
<b>Mullion</b>				
GD6206-G30	Inner gasket   2 and 3 mm   Fire protection G30	60	25	m
GD6226-G30	Inner gasket   4 and 5 mm   Fire protection G30	60	25	m
<b>Transom</b>				
GD6208-G30	Inner gasket   2 and 3 mm   Fire protection G30	60	25	m
GD6228-G30	Inner gasket   4 and 5 mm   Fire protection G30	60	25	m

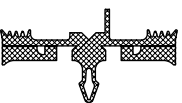
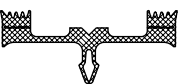

## Stabalux AK - System profile

### Add-on channel aluminum

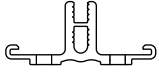

Item	Designation	PU	[..]
AK5010	Add-on channel brute   Slot hole 5,4 x 7,2 mm every 200 mm	6	m
AK6010	Add-on channel brute   Slot hole 5,4 x 7,2 mm every 200 mm	6	m

### Mounting of the AK6010 / AK5010 on steel

*different screw connections see processing notes chapter 3.1.1*

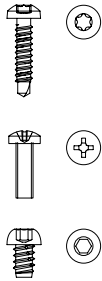

Item	Designation	Dimensions	PU	[..]
Z0171	Screw for thickness 2 - 4 mm	4,8 x 22 mm   bimetal	100	pc.
Z0172	Screw for thickness 2,5 - 6 mm	5,5 x 25 mm   bimetal	200	pc.
Z0173	Screw for thickness 4-12 mm	5,5 x 40 mm   bimetal	200	pc.
Z0174	Screw for thickness from 6 mm	M5 x 17 mm	100	pc.
Z0192	Screw for blind hole	6,3 x 9,5 mm	250	pc.

### Add-on channel steel

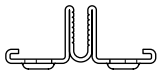

Item	Designation	PU	[..]
AK6020	Add-on channel galvanized   Slot hole 9,5 x 35 mm every 200 mm	6	m
AK6020s	Add-on channel blank   Slot hole 9,5 x 35 mm every 200 mm	6	m

### Mounting the AK6020 on steel

Welded joint see processing instructions „Welding instructions“.

## Stabalux AK - Glass support

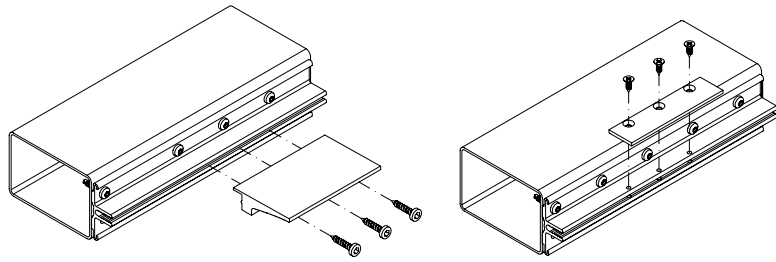

**Glass support for Stabalux AK; from 20 mm up to 60 mm glass thickness**  
*Use according to glass thickness and weight see processing instructions*

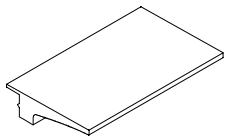

Item	Designation	Width x depth	PU	[..]
GH6071	Glass support	100 mm x 61,5 mm	1	pc.
GH6072	Glass support	200 mm x 61,5 mm	1	pc.

### Screw to fix glass support GH6071/GH6072

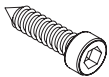

Item	Designation	Dimension	PU	[..]
Z0247	Cylinder head screw for GH	6,3 x 25 mm	200	pc.

### Glass support for Stabalux AK; from 10 mm up to 18 mm glass thickness

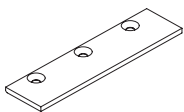

Item	Designation	Width x depth	PU	[..]
GH6073	Glass support	flat - 100 mm x 25 mm	1	pc.

### Screw to fix glass support GH6073



Item	Designation	Dimension	PU	[..]
Z0193	Screw for GH 6073	4,2 x 13 mm	100	pc.

## Stabalux AK - Inner gasket | Facade

### 2-level gasket | height 16.5 mm | overlapping

Item	Designation	System	PU	[..]
<b>Mullion</b>				
GD5071	Inner gasket	50	25	m
GD6071	Inner gasket	60	25	m
GD6075	Inner gasket   radius > 6mm	60	25	m
GD8071	Inner gasket	80	25	m
GD8077	Inner gasket   radius > 6mm	80	25	m
<b>Transom</b>				
GD5072	Inner gasket	50	25	m
GD6072	Inner gasket	60	25	m
GD6076	Inner gasket   radius > 6mm	60	25	m
GD8072	Inner gasket	80	25	m
GD8076	Inner gasket   radius > 6mm	80	20	m
<b>Sealing piece for transom end</b> (to use with connection paste Z0094)				
Z0062	Sealing piece EPDM (transom)	50, 60, 80	50	pc.

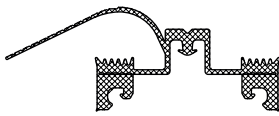

### Polygonal glazing mullion

Outside corner with 3° to 15°

GD6074	Inner gasket	60	25	m
--------	--------------	----	----	---

*in combination with 2-part outer gasket GD1925*

## Stabalux AK - Inner gasket | Roof

### 2-level gasket | height 16.5 mm | overlapping

Item	Designation	System	PU	[..]
<b>Mullion/rafter</b>				
GD5071	Inner gasket	50	25	m
GD6071	Inner gasket	60	25	m
GD8071	Inner gasket	80	25	m
<b>Transom</b>				
GD5073	Inner gasket	50	25	m
GD6073	Inner gasket	60	25	m
GD8073	Inner gasket	80	25	m
<b>Sealing piece for transom end</b> (to use with connection paste Z0094)				
Z0062	Sealing piece EPDM (transom)	50, 60, 80	50	pc.

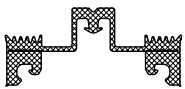
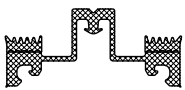

### 2-level gasket | height 22.5 mm | overlapping

<b>Mullion/rafter</b>				
GD6081	Inner gasket	(Glass ≥ 4mm)	60	25 m
<b>Transom</b>				
GD6083	Inner gasket	(Glass ≥ 4mm)	60	25 m

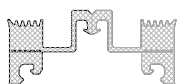
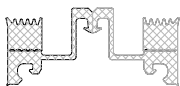

## Stabalux - System screws

### Stainless steel screw with cutting groove | sliding coated

Cylinder head screw  $\varnothing$  10 mm | with hexagon socket | **with** sealing washer



Item	Designation	Dimensions	PU	[..]
Z0148	Cylinder head screw	6,3 x 30 mm	200	pc.
Z0149	Cylinder head screw	6,3 x 35 mm	200	pc.
Z0151	Cylinder head screw	6,3 x 40 mm	200	pc.
Z0152	Cylinder head screw	6,3 x 45 mm	200	pc.
Z0153	Cylinder head screw	6,3 x 50 mm	200	pc.
Z0154	Cylinder head screw	6,3 x 55 mm	200	pc.
Z0155	Cylinder head screw	6,3 x 60 mm	200	pc.
Z0156	Cylinder head screw	6,3 x 65 mm	200	pc.
Z0157	Cylinder head screw	6,3 x 70 mm	200	pc.
Z0158	Cylinder head screw	6,3 x 75 mm	200	pc.
Z0161	Cylinder head screw	6,3 x 80 mm	200	pc.
Z0162	Cylinder head screw	6,3 x 85 mm	200	pc.
Z0163	Cylinder head screw	6,3 x 90 mm	200	pc.
Z0164	Cylinder head screw	6,3 x 95 mm	200	pc.
Z0165	Cylinder head screw	6,3 x 100 mm	200	pc.
Z0167	Cylinder head screw	6,3 x 110 mm	200	pc.
Z0166	Cylinder head screw	6,3 x 120 mm	200	pc.

### Stainless steel screw with cutting groove | sliding coated

Cylinder head screw  $\varnothing$  10 mm | with hexagon socket | **without** sealing washer

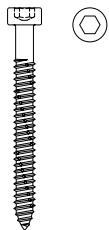

Item	Designation	Dimensions	PU	[..]
Z0293	Cylinder head screw	6,3 x 18 mm	250	pc.
Z0247	Cylinder head screw	6,3 x 25 mm	200	pc.
Z0253	Cylinder head screw	6,3 x 50 mm	250	pc.
Z0255	Cylinder head screw	6,3 x 60 mm	200	pc.
Z0257	Cylinder head screw	6,3 x 70 mm	200	pc.
Z0258	Cylinder head screw	6,3 x 75 mm	200	pc.
Z0241	Cylinder head screw	6,3 x 80 mm	200	pc.
Z0242	Cylinder head screw	6,3 x 85 mm	200	pc.
Z0243	Cylinder head screw	6,3 x 90 mm	200	pc.

### Washer



Item	Designation	Dimensions	PU	[..]
Z0033	PA washer	$\varnothing$ 10 (6,3) x 1,5 mm	100	pc.
Z0046	Washer stainless steel	with 2 mm seal	100	pc.
Z0086	Washer stainless steel	with 4 mm seal	100	pc.

## Stabalux - T-profiles

### T-profiles | hot rolled

Item	Designation	Dimensions	kg/m	PU	[..]
<b>System 50</b>					
T5050-6000	T-profil   S235   carbon	50/50 x 8,0 mm	5,9	6	m
T5080-6000	T-profil   S235   carbon	50/80 x 8,0 mm	7,8	6	m
<b>System 60</b>					
T60180-R-4000	T-profil   S235   carbon	60x10,0/180 x 8,0 mm   round	21,4	4	m
T60180-R-8000	T-profil   S235   carbon	60x10,0/180 x 8,0 mm   round	21,4	8	m
T60180-R-12000	T-profil   S235   carbon	60x10,0/180 x 8,0 mm   round	21,4	12	m

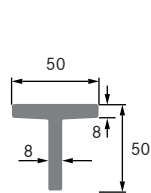

T5050

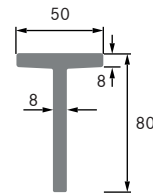

T5080

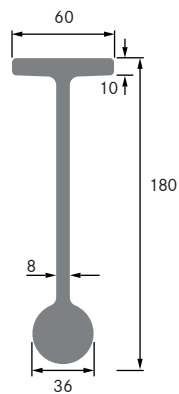

T60180-R

Stabalux - T-profiles fire protection - Inner gasket | Roof

G30 and F30 gaskets for T-profile

Gaskets are fixed **DIRECTLY** on the T-profile | no add-on system can be used

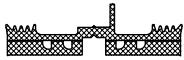

Item	Designation	System	PU	[..]
<b>Roof posts / rafters</b>				
GD6216-G30	Inner gasket   Fire protection G30	60	25	m
<b>Roof transom</b>				
GD6218-G30	Inner gasket   Fire protection G30	60	25	m

Stabalux - T-profiles fire protection - Screw connection

Screw nut



Item	Designation	Dimensions	PU	[..]
Z0043	Screw nut stainless steel	M6	100	pc.
<i>in connection with OL6012 and OL6069 only to be used without sealing washer</i>				

Washer



Item	Designation	Dimensions	PU	[..]
Z0046	Washer stainless steel	with 2 mm seal	100	pc.
Z0086	Washer stainless steel	with 4 mm seal	100	pc.

Threaded bolt



Item	Designation	Dimensions	PU	[..]
Z0034	Threaded bolt stainless steel	M6 x 20 mm	100	pc.
Z0038	Threaded bolt stainless steel	M6 x 25 mm	100	pc.
Z0035	Threaded bolt stainless steel	M6 x 30 mm	100	pc.
Z0040	Threaded bolt stainless steel	M6 x 35 mm	100	pc.
Z0036	Threaded bolt stainless steel	M6 x 40 mm	100	pc.
Z0037	Threaded bolt stainless steel	M6 x 50 mm	100	pc.
Z0044	Threaded bolt stainless steel	M6 x 60 mm	100	pc.
Z0045	Threaded bolt stainless steel	M6 x 75 mm	100	pc.
Z0039	Threaded bolt stainless steel	M6 x 90 mm	100	pc.
Z0053	Threaded bolt stainless steel	M6 x 100 mm	100	pc.
Z0054	Threaded bolt stainless steel	M6 x 120 mm	100	pc.

Threaded socket

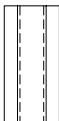

Item	Designation	Dimensions	PU	[..]
Z0029	Threaded socket stainless steel	M6 x 25 mm	100	pc.



## Stabalux - T-profiles fire protection - Glass support

Glass support for bolts  $\varnothing$  10 mm to max. 54 mm glass thickness

*The use of the glass supports can be found in the processing instructions*

Item	Designation	Dimensions (width 102 mm)	PU	[..]
GH0081	Glass support	Depth 9 mm	1	pc.
GH0082	Glass support	Depth 24 mm	1	pc.
GH0083	Glass support	Depth 26 mm	1	pc.
GH0084	Glass support	Depth 28 mm	1	pc.
GH0085	Glass support	Depth 30 mm	1	pc.
GH0886	Glass support	Depth 32 mm	1	pc.
GH0887	Glass support	Depth 35 mm	1	pc.
GH0888	Glass support	Depth 38 mm	1	pc.
GH0889	Glass support	Depth 41 mm	1	pc.
GH0890	Glass support	Depth 44 mm	1	pc.
GH0891	Glass support	Depth 47 mm	1	pc.
GH0892	Glass support	Depth 50 mm	1	pc.
GH0893	Glass support	Depth 53 mm	1	pc.
GH0894	Glass support	Depth 56 mm	1	pc.
GH5053	Glass support	Extrudes profil	6	m

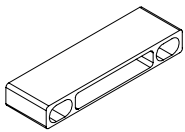

Item	Designation	Dimensions (width 200 mm)	PU	[..]
GH0851	Glass support	Depth 26 mm	1	pc.
GH0852	Glass support	Depth 28 mm	1	pc.
GH0853	Glass support	Depth 30 mm	1	pc.
GH0854	Glass support	Depth 32 mm	1	pc.
GH0855	Glass support	Depth 35 mm	1	pc.
GH0856	Glass support	Depth 38 mm	1	pc.
GH0857	Glass support	Depth 41 mm	1	pc.
GH0858	Glass support	Depth 44 mm	1	pc.
GH0859	Glass support	Depth 47 mm	1	pc.
GH0860	Glass support	Depth 50 mm	1	pc.
GH0861	Glass support	Depth 53 mm	1	pc.
GH0862	Glass support	Depth 56 mm	1	pc.

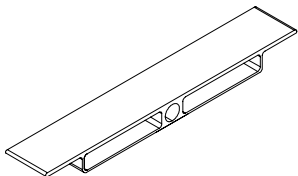

## Stabalux - Fire protection

## Fire protection glasses

*We deliver fire protection glass within the scope of our current approvals (Pyran S and ISO-Pyran S, Pyroswiss and Pyrostop)*

## Nameplates for fire protection glazing

Item	Designation		PU	[..]
Z1235	Nameplate G30 roof	Approval Z-19.14-1235	1	pc.
Z1451	Nameplate F30 Facade	Approval Z-19.14-1451	1	pc.

## Foil, fire protection quality for G30

Z0059	Waterproofing membrane BS	330 x 1 mm	25	m
-------	---------------------------	------------	----	---

*(one side smooth, other side 5 mm subdivision)*

## Outer gasket | Facade

### 1-piece outer gasket

Item	Designation	System	PU	[..]
GD5024	Outer gasket	50	25	m
GD6024	Outer gasket	60	25	m
GD6024-G30	Outer gasket	Fire protection G30	60	25 m
GD6024-F30	Outer gasket	Fire protection F30	60	25 m
GD8024	Outer gasket	80	25	m
GD5054	Outer gasket	Transom	50	25 m
GD6054	Outer gasket	Transom	60	25 m
GD8054	Outer gasket	Transom	80	25 m



### Outer gaskets for stainless steel bottom strips UL6110 | UL6110c

GD6022-G30	Outer gasket	Fire protection G30	60	25 m
GD6022-F30	Outer gasket	Fire protection F30	60	25 m
GD6122-WK	Outer gasket	Burglar resistance RC2   RC3	60	25 m



### 2-piece outer gasket system 50 | 60 | 80 mm

Item	Designation	PU	[..]
GD1932	Outer gasket   2-piece 5 mm	25	m
GD1934	Outer gasket   2-piece 4 mm	25	m
GD1936	Outer gasket   2-piece 6 mm	25	m
GD1938	Outer gasket   2-piece 8 mm	25	m
GD1940	Outer gasket   2-piece 10 mm	25	m
GD1925	Outer gasket   2-piece for outside corner polygonal 3°-15°	25	m
GD1928	Outer gasket   2-piece for inner corner polygonal 3°-10°	25	m
GD6174	Outer gasket   2-piece Mullion DL5073   DL6073	25	m
GD6175	Outer gasket   2-piece Transom DL5073   DL6073	25	m

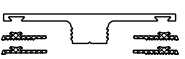
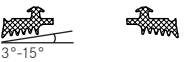

## Outer gasket | Roof

### 1-piece outer gasket

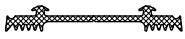

Item	Designation	System	PU	[..]
GD5024	Outer gasket	50	25	m
GD6024	Outer gasket	60	25	m
GD8024	Outer gasket	80	25	m

### Stainless steel sealing plate

(for additional tightness in sloped glazing up to 10° inclination)

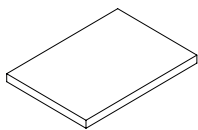

Item	Designation	Dimensions	System	PU	[..]
Z0501	Stainless steel sealing plate	60 x 40 mm	50	10	pc.
Z0601	Stainless steel sealing plate	60 x 50 mm	60	10	pc.
Z0801	Stainless steel sealing plate	70 x 70 mm	80	10	pc.

### 1-piece outer gasket fire protection from 15° up to 80° inclination



Item	Designation	System	PU	[..]
GD6024-G30	Outer gasket	Fire protection G30	60	25 m
GD6022-G30	Outer gasket	Fire protection G30	60	25 m

### Hold-down clamp

With a roof pitch of  $\leq 5^\circ$ , there is no cover plate in the transom. In order to ensure that rainwater and dirt run off freely, the rebate is sealed with weather silicone. Hold-down devices are to be used to support the glass edges.

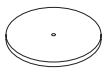

Item	Designation	Dimensions (W x H)	PU	[..]
Z0020	Hold-down stainless steel	round   50 x 8 mm	10	pc.
GD5009	Washer for Z0020	round   50 x 3 mm	50	pc.

### Insulation block

When sealing the rebate area of the bolt with weather silicone, insulation blocks can serve as backfill material.

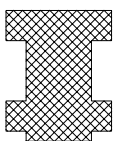

Item	Designation	Dimensions (L x W x H)	PU	[..]
Z0610	Insulation block 20 / 5,2 (flat)	2.000 x 20 x 5,2 mm	50	m
Z0609	Insulation block 20 / 10,4 (T-form)	2.000 x 20 x 10,4 mm	50	m
Z0606	Insulation block 20 / 26	2.000 x 20 x 26 mm	50	m
Z0605	Insulation block 20 / 42	2.000 x 20 x 42 mm	50	m

## Pressure plates with visible screw connections

### Pressure plates made of aluminum



Item	Designation	Dimensions (W x H x L)	System	PU	[..]
DL5067	Pressure plate blank	50 x 6 x 6000 mm	50	6	m
DL6067	Pressure plate blank	60 x 6 x 6000 mm	60	6	m



DL5071	Pressure plate blank	50 x 6 x 6000 mm	50	6	m
DL6071	Pressure plate blank	60 x 6 x 6000 mm	60	6	m
DL6071-ELO	Pressure plate E6EV1	60 x 6 x 6000 mm	60	6	m



DL5059	Pressure plate blank	50 x 8 x 6000 mm	50	6	m
DL6059	Pressure plate blank	60 x 8 x 6000 mm	60	6	m
DL6059-ELO	Pressure plate E6EV1	60 x 8 x 6000 mm	60	6	m
DL8059	Pressure plate blank	80 x 8 x 6000 mm	80	6	m



DL5061	Pressure plate blank	50 x 25 x 6000 mm	50	6	m
DL6061	Pressure plate blank	60 x 25 x 6000 mm	60	6	m
DL6061-ELO	Pressure plate E6EV1	60 x 25 x 6000 mm	60	6	m

### Pressure plates made of aluminum for SG-like glazing



Item	Designation	Dimensions (W x H x L)	System	PU	[..]
DL5073	Flat pressure plate blank	50 x 2,5 x 6000 mm	50	6	m
DL6073	Flat pressure plate blank	60 x 2,5 x 6000 mm	60	6	m

### Cover plug for flat pressure plate DL5073 | DL6073



Item	Designation	PU	[..]
Z0089	Cover plug for DL5073   DL6073	250	pc.

### Stainless steel pressure plate

Upper profile 1.4571 | Sub-profile 1.4301 | sanded grain 240 | one-sided foil



Item	Designation	Dimensions (W x H x L)	System	PU	[..]
DL6044	Stainless steel pressure plate	60 x 20 x 6000 mm	60	6*	m

*Lower profile perforated Ø7 mm every 125 mm*

\*Usable length = 5990 mm

### Stainless steel pressure plates

Flat cover strip 1.4301 | 2 B



Item	Designation	Dimensions (W x H x L)	System	PU	[..]
DL6018	Stainless steel pressure plate	59 x 3 x 6000 mm	60	6	m

*in combination with 2-part outer gasket GD6940*

## Pressure plates with concealed screw connections

### Stainless steel cover plate

1.4401 | ground grit 220 | one-sided foil

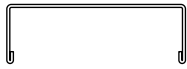

Item	Designation	Dimensions (W x H x L)	System	PU	[..]
OL6064	Stainless steel cover plate	60 x 20 x 6000 mm	60	6	m

### Aluminum pressure plate for OL6064



UL6007-L <sup>1)</sup>	Pressure plate	57 x 6000 mm	60	6	m
------------------------	----------------	--------------	----	---	---

### Pressure plates made of aluminum

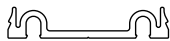

Item	Designation	Dimensions (W x L)	System	PU	[..]
UL5009	Pressure plate	46 x 6000 mm	50	6	m
UL5009-L <sup>1)</sup>	Pressure plate	46 x 6000 mm	50	6	m
UL6009	Pressure plate	54,2 x 6000 mm	60	6	m
UL6009-L <sup>1)</sup>	Pressure plate	54,2 x 6000 mm	60	6	m
UL8009-L <sup>1)</sup>	Pressure plate	76 x 6000 mm	80	6	m

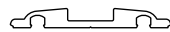

UL6005-L <sup>1)</sup>	Pressure plate	56 x 6000 mm	60	6	m
------------------------	----------------	--------------	----	---	---

Only for OL6066

Special screw cylinder head with hexagon socket without sealing washer e.g. Z0253, Z0254

<sup>1)</sup> Long hole 7 x 10 mm every 125 mm

### Stainless steel pressure plates

1.4301

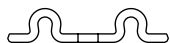

Item	Designation	Dimensions (W x L)	System	PU	[..]
UL6110 <sup>2) 4)</sup>	Stainless steel pressure plates	56 x 6000 mm	60	6 <sup>5)</sup>	m
UL6110c <sup>2) 4)</sup>	Galvanized pressure plates	56 x 6000 mm	60	6 <sup>5)</sup>	m

for fire protection G30 / F30 | for burglar resistance RC2

<sup>2)</sup> Long hole 7 x 10 mm every 250 mm;







<sup>3)</sup> for GD5122-WK;

<sup>4)</sup> for GD6022-G30/F30 & GD6122-WK ;

<sup>5)</sup> Useful length = 5990 mm

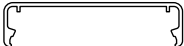
## Cover plates with concealed screw connections

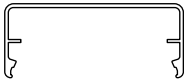
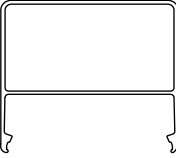
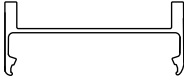
### Cover plates made of aluminum

Item	Designation	Dimensions (W x H x L)	System	PU	[..]	
	OL5025	Cover plate blank	50 x 15 x 6000 mm; radius 0,5	50	6	m
	OL6011	Cover plate blank	60 x 13 x 6000 mm	60	6	m
		<i>only use with screw (e.g. Z0249) and separate sealing washer Z0033!</i>				
	OL5012	Cover plate blank	50 x 15 x 6000 mm	50	6	m
	OL6012	Cover plate blank	60 x 15 x 6000 mm	60	6	m
	OL6012-ELO	Cover plate E6EV1	60 x 15 x 6000 mm	60	6	m
	OL8012	Cover plate blank	80 x 15 x 6000 mm	80	6	m
	OL5013	Cover plate blank	50 x 18 x 6000 mm	50	6	m
	OL6013	Cover plate blank	60 x 18 x 6000 mm	60	6	m
	OL6013-ELO	Cover plate E6EV1	60 x 18 x 6000 mm	60	6	m
	OL8013	Cover plate blank	80 x 18 x 6000 mm	80	6	m
	OL5014	Cover plate blank	50 x 25 x 6000 mm	50	6	m
	OL6014	Cover plate blank	60 x 25 x 6000 mm	60	6	m
	OL6014-ELO	Cover plate E6EV1	60 x 25 x 6000 mm	60	6	m
	OL8014	Cover plate blank	80 x 25 x 6000 mm	80	6	m
	OL6015	Cover plate blank	60 x 50 x 6000 mm	60	6	m
	OL8015	Cover plate blank	80 x 50 x 6000 mm	80	6	m
	OL6081	Cover plate blank	60 x 150 x 6700 mm	60	6,7	m
	OL5016	Cover plate blank	50 x 25 x 6000 mm	50	6	m
	OL6016	Cover plate blank	60 x 25 x 6000 mm	60	6	m
	OL6066	Cover plate blank	60 x 12,3 x 6000 mm	60	6	m
		<i>Only use with UL6005!</i>				

## Stabalux equipment

## Tools &amp; accessories for seals

Item	Designation		PU	[..]
Z0056	Scissors		1	pc.
Z0077	Notching pliers	System 50	1	pc.
Z0078	Notching pliers	System 60	1	pc.
Z0094	Stabalux connection paste	310 ml   black	1	pc.
<i>1 box = 12 pieces</i>				

## Burglar resistance accessories

Item	Designation		PU	[..]
Z1061	Blocking (side) 20x24	for RC2   RC3	6	m
Z0093	Screw locking	Stainless steel ball; Ø 5.0 mm	100	pc.
<i>for screw locking RC2 and RC3; bonding e.g. with Z0055</i>				

## Cross bars for end fields

Item	Designation	Dimensions (L x W x H)	PU	[..]
Z1061	Rigid PVC cross bars; Gray	6000 x 20 x 24 mm	6	m
Z1062	Rigid PVC cross bars; Gray	6000 x 22 x 26 mm	6	m
Z1063	Rigid PVC cross bars; Gray	6000 x 28 x 30 mm	6	m
Z1064	Rigid PVC cross bars; Gray	6000 x 32 x 34 mm	6	m
Z1065	Rigid PVC cross bars; Gray	6000 x 36 x 38 mm	6	m
Z1066	Rigid PVC cross bars; Gray	6000 x 40 x 42 mm	6	m

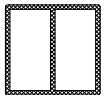

## Insulation blocks for the glass rebate area

*with permanent HOT-MELT; insert with split seal*

Item	Designation	Dimensions (L x W x H)	PU	[..]
<b>Rebate width 20 mm</b>				
Z0606	Insulation block 20 / 26	2000 x 20 x 26 mm	50	m
Z0605	Insulation block 20 / 42	2000 x 20 x 42 mm	50	m
<b>Rebate width 30 mm</b>				
Z0608	Insulation block 30 / 26	2000 x 30 x 26 mm	50	m
Z0607	Insulation block 30 / 42	2000 x 30 x 42 mm	50	m

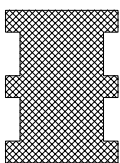

## Gaskets | System-independent

### Gaskets without radius



Item	Designation	System	PU	[..]
GD5940	Gasket   height 5 mm	50	25	m
GD6940	Gasket   height 5 mm	60	25	m
GD6940-G30	Gasket   height 5 mm   fire protection G30	60	25	m
GD6940-F30	Gasket   height 5 mm   fire protection F30	60	25	m



GD6026	Gasket   height 5 mm   mullion/transom	60	25	m
--------	--	----	----	---



GD0035	Gasket   self-adhesive   14 x 5 mm		100	m
--------	------------------------------------	--	-----	---



SG990011GD	Inner gasket	height 3 mm	50	25	m
------------	--------------	-------------	----	----	---

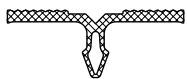

SG990002GD	Inner gasket	height 3 mm	45	25	m
------------	--------------	-------------	----	----	---

SG990001GD	Inner gasket	height 3 mm	50	25	m
------------	--------------	-------------	----	----	---

### Gaskets with radius 3 mm



GD5915-SK	Gasket   self-adhesive	50	25	m
-----------	------------------------	----	----	---

GD6916-SK	Gasket   self-adhesive	60	25	m
-----------	------------------------	----	----	---

### Gaskets with radius 8 mm



GD5921	Inner gasket	50	25	m
--------	--------------	----	----	---

GD5921-SK	Gasket   self-adhesive	50	25	m
-----------	------------------------	----	----	---

### Gaskets with radius 12 mm



GD5925	Inner gasket	50	25	m
--------	--------------	----	----	---

### Gasket sloping glazing with a radius of 3 mm



Item	Designation	System	PU	[..]
<b>Mullion</b>				
GD6946	Inner gasket	60	25	m



<b>Transom</b>				
GD5901	Inner gasket	50	25	m
GD6902	Inner gasket	60	25	m