

General informations

Item information

For individual items, the dimensions can be read from the item number.

- Gaskets – GD5201-G30 | Width 50 mm / Fire protection G30
- Cover and pressure plates – DL5067-ELO | Width 50 mm / anodized

Articles with article numbers beginning with 50 are for systems with a width of 50 mm.

Articel availability

Normally all items listed with a price are in stock and can be delivered immediately.

Packing units [PU]

- Gaskets (GD) 25 m in a box (unless otherwise specified).
- Screws and bolts, depending on the version, 100 pieces or 200 pieces in a box.
- Tubes, profiles and bar stock per specified storage length.
- Special accessories, tools and various small items per version 1 pc. or 10 pc.

Order quantities that differ from the packaging units [PU] are confirmed and delivered in the next higher PU.

With surface-processed cover strips, the usable length is reduced by approx. 50 mm at the profile ends.

Special lengths for bar goods (screw tubes, T-profiles, top, cover and bottom strips) on request.

The technical drawings shown in the price list are not to scale. For technical details, see product information.

We do not accept any liability for errors or misprints.

Order

Please fax or email your order to our order processing department:

Fax: **+49 228 909043-11**
Mail: **c.service@stabalux.com**

Stabalux GmbH

Fraunhoferstraße 8
53121 Bonn - Germany
Phone +49 228 909043-0
Fax +49 228 909043-11
info@stabalux.com

Stabalux AL Threaded Tubes | AW 6060 T66

Item	Designation	Dimensions	PU	[..]
System 50				
AL5040	AL tube AW 6060 T66	50x40 / 6000 mm	6	m
AL5060	AL tube AW 6060 T66	50x60 / 6000 mm	6	m
AL5090	AL tube AW 6060 T66	50x90 / 6000 mm	6	m
AL50120	AL tube AW 6060 T66	50x120 / 6000 mm	6	m
AL50120-R	AL tube AW 6060 T66	50x120 / 6000 mm radius 2 mm	6	m
AL50150	AL tube AW 6060 T66	50x150 / 6000 mm	6	m
AL50150-R	AL tube AW 6060 T66	50x150 / 6000 mm radius 2 mm	6	m
AL50200	AL tube AW 6060 T66	50x200 / 6000 mm	6	m
AL50250	AL tube AW 6060 T66	50x250 / 6000 mm	6	m
AL9090	AL tube AW 6060 T66	90x90 / 6000 mm corner profile	6	m

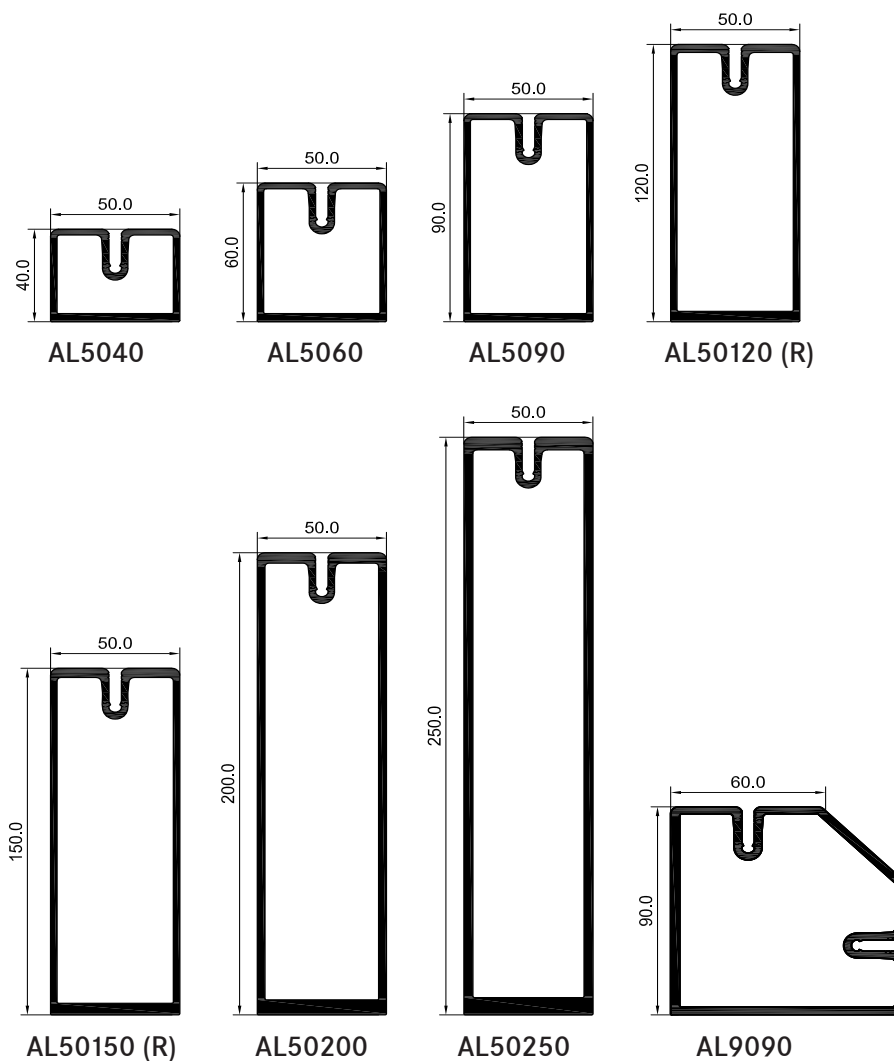

Stabalux AL - Mullion-Transom-Connector

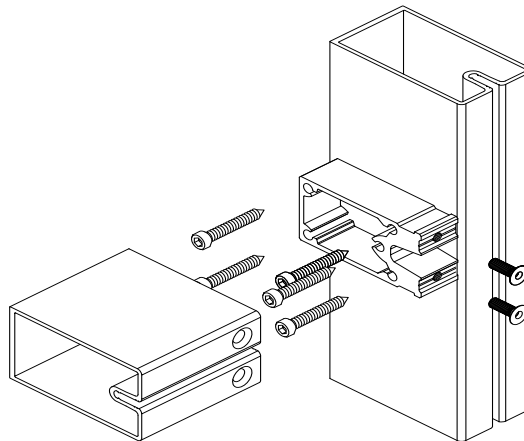

T-Connector aluminum

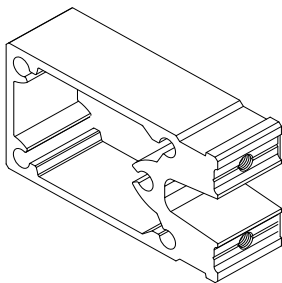

Item	Designation	Dimensions	System	PU	[..]
TVA 5040	T-Connector for AL5040	44,4 x 33 x 25 mm (2)	50	1	pc.
TVA 5060	T-Connector for AL5060	44,4 x 53 x 25 mm (5)	50	1	pc.
TVA 5090	T-Connector for AL5090	44,4 x 83 x 25 mm (5)	50	1	pc.
TVA 50120	T-Connector for AL50120	44,4 x 111 x 25 mm (5)	50	1	pc.
TVA 50150	T-Connector for AL50150	44,4 x 140 x 25 mm (5)	50	1	pc.
TVA 50200	T-Connector for AL50200	43,4 x 188 x 25 mm (5)	50	1	pc.
TVA 50250	T-Connector for AL50250	43,4 x 236 x 25 mm (5)	50	1	pc.

Screws

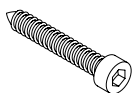

Item	Designation	Dimensions	PU	[..]
Z0118	Screw for T-Connector	6,3 x 40 mm	200	pc.
Z0128	Fixing screw transom	M6 x 18 mm	200	pc.

Stabalux AL - Glass support

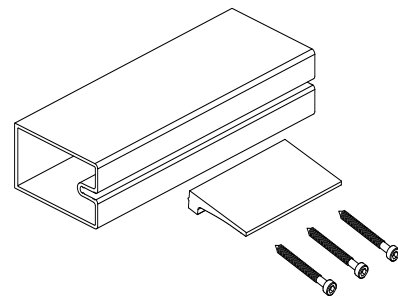
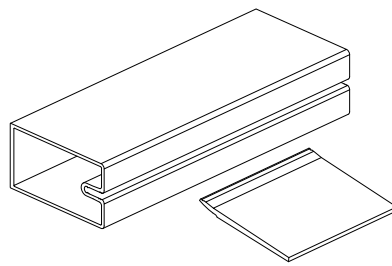

Screwed glass support GH 5201 | GH 5202

for glass thickness up to 64 mm

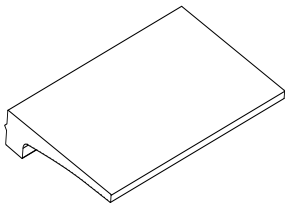

Item	Designation	Width x depth	PU	[..]
GH 5201	Glass support (3 screws)	100 mm x 65 mm	1	Stk.
GH 5202	Glass support (6 screws)	200 mm x 65 mm	1	Stk.

Screw connection

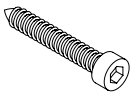

Item	Designation	Dimensions	PU	[..]
Z0118	Screw for GH5201 GH 5202	6,3 x 40 mm	200	Stk.

Insert glass support GH 5101 | GH 5102

for glass thickness up to 70 mm

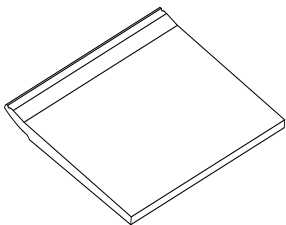

Item	Designation	Width x depth	PU	[..]
GH 5101	Glass support	100 mm x 90,6 mm	1	Stk.
GH 5102	Glass support	200 mm x 90,6 mm	1	Stk.

Stabalux AL - Inner gasket | Facade

Gasket | height 5 mm | butt joint

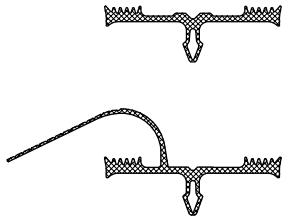

Item	Designation	System	PU	[..]
Mullion				
GD5201	Inner gasket 2 and 3 mm	50	25	m
Transom				
GD5203	Inner gasket 2 and 3 mm	50	25	m
GD5204	Inner gasket 2 and 3 mm (Glass \geq 50 mm)	50	25	m

3-level gasket | height 12 mm | overlapping

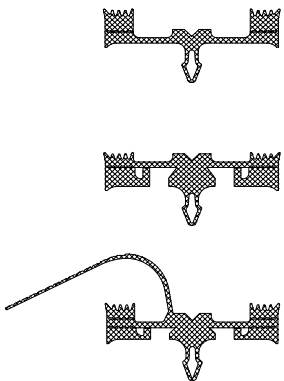

Item	Designation	System	PU	[..]
Main mullion				
GD5314	Inner gasket 2 and 3 mm	50	25	m
Secondary mullion				
GD5315	Inner gasket 2 and 3 mm	50	25	m
Transom				
GD5317	Inner gasket 2 and 3 mm (Glass \leq 50 mm)	50	25	m

Stabalux AL - Inner gasket | Roof

Roof system | height 10 mm | overlapping

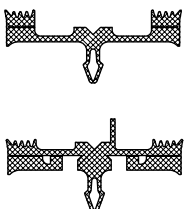

Item	Designation	System	PU	[..]
Mullion				
GD5205	Inner gasket 2 and 3 mm	50	25	m
Transom				
GD5207	Inner gasket 2 and 3 mm	50	25	m

Outer gasket | Facade

1-piece outer gasket

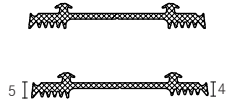

Item	Designation	System	PU	[..]
GD5024	Outer gasket	50	25	m
GD5054	Outer gasket	Transom	50	25 m

2-piece outer gasket system 50 mm

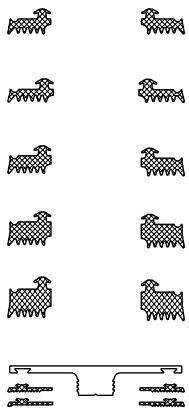

Item	Designation	PU	[..]
GD1932	Outer gasket 2-piece 5 mm	25	m
GD1934	Outer gasket 2-piece 4 mm	25	m
GD1936	Outer gasket 2-piece 6 mm	25	m
GD1938	Outer gasket 2-piece 8 mm	25	m
GD1940	Outer gasket 2-piece 10 mm	25	m
GD6174	Outer gasket 2-piece Mullion DL5073	25	m
GD6175	Outer gasket 2-piece Transom DL5073	25	m

Outer gasket | Roof

1-piece outer gasket



Item	Designation	System	PU	[..]
GD5024	Outer gasket	50	25	m

Stainless steel sealing plate

(for additional tightness in sloped glazing up to 10° inclination)

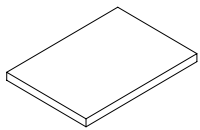

Item	Designation	Dimensions	System	PU	[..]
Z0501	Stainless steel sealing plate	60 x 40 mm	50	10	pc.

Hold-down clamp for roof systems

With a roof pitch $\leq 5^\circ$, there is no cover plate in the transom. In order to ensure that rainwater and dirt run off freely, the rebate is sealed with weather silicone. Hold-down devices are to be used to support the glass edges.

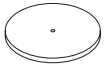
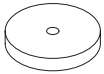

Item	Designation	Dimensions (W x H)	PU	[..]
Z0020	Hold-down stainless steel	round 50 x 8 mm	10	pc.
GD5009	Washer for Z0020	round 50 x 3 mm	50	pc.

Insulation block

When sealing the rebate area of the bolt with weather silicone, insulation blocks can serve as backfill material.

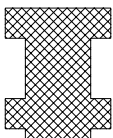

Item	Designation	Dimensions (L x W x H)	PU	[..]
Z0610	Insulation block 20 / 5,2 (flat)	2.000 x 20 x 5,2 mm	50	m
Z0609	Insulation block 20 / 10,4 (T-form)	2.000 x 20 x 10,4 mm	50	m
Z0606	Insulation block 20 / 26	2.000 x 20 x 26 mm	50	m
Z0605	Insulation block 20 / 42	2.000 x 20 x 42 mm	50	m

Pressure plates with visible screw connections

Pressure plates made of aluminum



Item	Designation	Dimensions (W x H x L)	System	PU	[..]
DL5067	Pressure plate blank	50 x 6 x 6000 mm	50	6	m

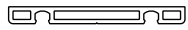

DL5071	Pressure plate blank	50 x 6 x 6000 mm	50	6	m
--------	----------------------	------------------	----	---	---

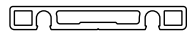

DL5059	Pressure plate blank	50 x 8 x 6000 mm	50	6	m
--------	----------------------	------------------	----	---	---



DL5061	Pressure plate blank	50 x 25 x 6000 mm	50	6	m
--------	----------------------	-------------------	----	---	---

Pressure plates made of aluminum for SG-like glazing



Item	Designation	Dimensions (W x H x L)	System	PU	[..]
DL5073	Flat pressure plate blank	50 x 2,5 x 6000 mm	50	6	m

Cover plug for flat pressure plate DL5073



Item	Designation	PU	[..]
Z0089	Cover plug for DL5073	250	pc.

Pressure plates with concealed screw connections

Pressure plates made of aluminum

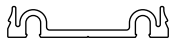

Item	Designation	Dimensions (W x L)	System	PU	[..]
UL5009	Pressure plate blank	46 x 6000 mm	50	6	m
UL5009-L ¹⁾	Pressure plate blank	46 x 6000 mm	50	6	m

¹⁾ Long hole 7 x 10 mm every 125 mm

Cover plates made of aluminum

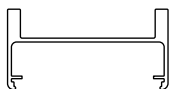

Item	Designation	Dimensions (W x H x L)	System	PU	[..]
OL5025	Cover plate blank	50 x 15 x 6000 mm radius 0,5	50	6	m
OL5012	Cover plate blank	50 x 15 x 6000 mm	50	6	m
OL5013	Cover plate blank	50 x 18 x 6000 mm	50	6	m
OL5014	Cover plate blank	50 x 25 x 6000 mm	50	6	m
OL5016	Cover plate blank	50 x 25 x 6000 mm	50	6	m

Stabalux - System screws

Stainless steel screw with cutting groove | sliding coated

Cylinder head screw \varnothing 10 mm | with hexagon socket | **with** sealing washer



Item	Designation	Dimensions	PU	[..]
Z0148	Cylinder head screw	6,3 x 30 mm	200	pc.
Z0149	Cylinder head screw	6,3 x 35 mm	200	pc.
Z0151	Cylinder head screw	6,3 x 40 mm	200	pc.
Z0152	Cylinder head screw	6,3 x 45 mm	200	pc.
Z0153	Cylinder head screw	6,3 x 50 mm	200	pc.
Z0154	Cylinder head screw	6,3 x 55 mm	200	pc.
Z0155	Cylinder head screw	6,3 x 60 mm	200	pc.
Z0156	Cylinder head screw	6,3 x 65 mm	200	pc.
Z0157	Cylinder head screw	6,3 x 70 mm	200	pc.
Z0158	Cylinder head screw	6,3 x 75 mm	200	pc.
Z0161	Cylinder head screw	6,3 x 80 mm	200	pc.
Z0162	Cylinder head screw	6,3 x 85 mm	200	pc.
Z0163	Cylinder head screw	6,3 x 90 mm	200	pc.
Z0164	Cylinder head screw	6,3 x 95 mm	200	pc.
Z0165	Cylinder head screw	6,3 x 100 mm	200	pc.
Z0167	Cylinder head screw	6,3 x 110 mm	200	pc.
Z0166	Cylinder head screw	6,3 x 120 mm	200	pc.

Stainless steel screw with cutting groove | sliding coated

Cylinder head screw \varnothing 10 mm | with hexagon socket | **without** sealing washer

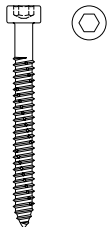

Item	Designation	Dimensions	PU	[..]
Z0293	Cylinder head screw	6,3 x 18 mm	250	pc.
Z0247	Cylinder head screw	6,3 x 25 mm	200	pc.
Z0253	Cylinder head screw	6,3 x 50 mm	250	pc.
Z0255	Cylinder head screw	6,3 x 60 mm	200	pc.
Z0257	Cylinder head screw	6,3 x 70 mm	200	pc.
Z0258	Cylinder head screw	6,3 x 75 mm	200	pc.
Z0241	Cylinder head screw	6,3 x 80 mm	200	pc.
Z0242	Cylinder head screw	6,3 x 85 mm	200	pc.
Z0243	Cylinder head screw	6,3 x 90 mm	200	pc.

Washer



Item	Designation	Dimensions	PU	[..]
Z0033	PA washer	\varnothing 10 (6,3) x 1,5 mm	100	pc.
Z0046	Washer stainless steel	with 2 mm seal	100	pc.
Z0086	Washer stainless steel	with 4 mm seal	100	pc.

Stabalux Equipment

Tools & accessories for seals

Item	Designation		PU	[..]
Z0056	Scissors		1	pc.
Z0077	Notching pliers	System 50	1	pc.
Z0094	Stabalux connection paste	310 ml black	1	pc.
<i>1 box = 12 pieces</i>				

Cross bars for end fields

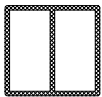

Item	Designation	Dimensions (L x W x H)	PU	[..]
Z1061	rigid PVC cross bars; gray	6000 x 20 x 24 mm	6	m
Z1062	rigid PVC cross bars; gray	6000 x 22 x 26 mm	6	m
Z1063	rigid PVC cross bars; gray	6000 x 28 x 30 mm	6	m
Z1064	rigid PVC cross bars; gray	6000 x 32 x 34 mm	6	m
Z1065	rigid PVC cross bars; gray	6000 x 36 x 38 mm	6	m
Z1066	rigid PVC cross bars; gray	6000 x 40 x 42 mm	6	m

Insulation blocks for the glass rebate area



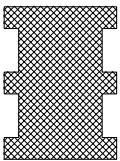

with permanent HOT-MELT; insert with split seal

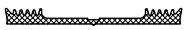

Item	Designation	Dimensions (L x W x H)	PU	[..]
Rebate width 20 mm				
Z0606	insulation block 20 / 26	2000 x 20 x 26 mm	50	m
Z0605	insulation block 20 / 42	2000 x 20 x 42 mm	50	m

Gaskets | System-independent

Gaskets without radius

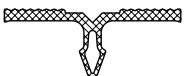
Item	Designation	System	PU	[..]
	GD5940 Gasket height 5 mm	50	25	m
	GD6940 Gasket height 5 mm	60	25	m
	GD6940-G30 Gasket height 5 mm fire protection G30	60	25	m
	GD6940-F30 Gasket height 5 mm fire protection F30	60	25	m
	GD6026 Gasket height 5 mm mullion/transom	60	25	m
	GD0035 Gasket self-adhesive 14 x 5 mm		100	m
	SG990011GD Inner gasket height 3 mm	50	25	m
	SG990002GD Inner gasket height 3 mm	45	25	m
	SG990001GD Inner gasket height 3 mm	50	25	m

Gaskets with radius 3 mm

	GD5915-SK Gasket self-adhesive	50	25	m
	GD6916-SK Gasket self-adhesive	60	25	m



Gaskets with radius 8 mm

	GD5921 Inner gasket	50	25	m
	GD5921-SK Gasket self-adhesive	50	25	m

Gaskets with radius 12 mm

	GD5925 Inner gasket	50	25	m
---	---------------------	----	----	---

Gasket sloping glazing with a radius of 3 mm

Item	Designation	System	PU	[..]
Mullion				
	GD6946 Inner gasket	60	25	m
Transom				
	GD5901 Inner gasket	50	25	m
	GD6902 Inner gasket	60	25	m