

General informations

Item information

For individual items, the dimensions can be read from the item number.

- Gaskets – GD5201 | Width 50 mm
- Cover and pressure plates – DL6067-ELO | Width 60 mm / anodized

Articles with article numbers beginning with 50 are for systems with a width of 50 mm, articles with article numbers beginning with 60 are for systems with a width of 60 mm.

Articel availability

Normally all items listed with a price are in stock and can be delivered immediately.

Packing units [PU]

- Gaskets (GD) 25 m in a box (unless otherwise specified).
- Screws and bolts, depending on the version, 100 pieces or 200 pieces in a box.
- Tubes, profiles and bar stock per specified storage length.
- Special accessories, tools and various small parts per version 1 pc. or 10 pc.

Order quantities that differ from the packaging units [PU] are confirmed and delivered in the next higher PU.

With surface-processed cover strips, the usable length is reduced by approx. 50 mm at the profile ends.

Special lengths for bar goods (top, cover and bottom strips) on request.

The technical drawings shown in the price list are not to scale. For technical details, see product information.

We do not accept any liability for errors or misprints.

Order

Please fax or email your order to our order processing department:

Fax: **+49 228 909043-11**

Mail: **c.service@stabalux.com**

Stabalux GmbH

Fraunhoferstraße 8

53121 Bonn - Germany

Phone +49 228 909043-0

Fax +49 228 909043-11

Stabalux H - Inner gasket | Facade

Gasket | height 5 mm | butt joint

Item	Designation	System	PU	[..]
Mullion				
GD5201	Inner gasket	50	25	m
GD6202	Inner gasket	60	25	m
GD6202-F30	Inner gasket Fire protection F30	60	25	m
GD8202	Inner gasket	80	25	m
Transom				
GD5203	Inner gasket	50	25	m
GD5204	Inner gasket (glass > 50 mm)	50	25	m
GD6204	Inner gasket	60	25	m
GD6205	Inner gasket (glass > 50 mm)	60	25	m
GD6204-F30	Inner gasket Fire protection F30	60	25	m
GD8204	Inner gasket	80	25	m

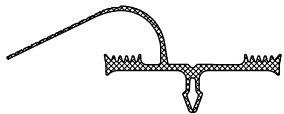
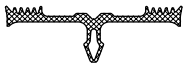

2-level gasket | height 10 mm | overlapping

Item	Designation	System	PU	[..]
Mullion				
GD6206	Inner gasket	60	25	m
GD8206	Inner gasket	80	25	m
Transom				
GD6303	Inner gasket	60	25	m
GD8303	Inner gasket	80	25	m

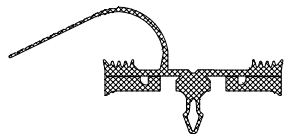
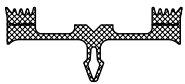

3-level gasket | height 12 mm | overlapping

Item	Designation	System	PU	[..]
Main mullion				
GD5314	Inner gasket	50	25	m
GD6314	Inner gasket	60	25	m
Secondary mullion				
GD5315	Inner gasket	50	25	m
GD6315	Inner gasket	60	25	m
Transom				
GD5317	Inner gasket (glass ≤ 50 mm)	50	25	m
GD6318	Inner gasket	60	25	m

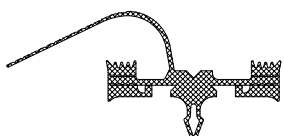
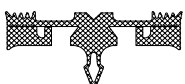
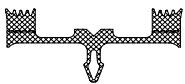

Stabalux H - Inner gasket | Facade

Polygonal glazing mullion

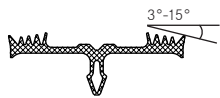

Item	Designation	System	PU	[..]
Outside corner with 3° to 15 °				
GD6210	Inner gasket <i>in combination with 2-part outer seal GD1925</i>	60	25	m

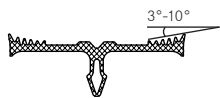

Inside corner with 3° to 10 °				
GD6211	Inner gasket <i>in combination with 2-part outer seal GD1928</i>	60	25	m

Stabalux H - Inner gasket | Roof

Roof system | height 10 mm | overlapping

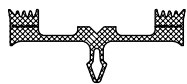

Item	Designation	System	PU	[..]
Mullion				
GD5205	Inner gasket	50	25	m
GD6206	Inner gasket	60	25	m
GD8206	Inner gasket	80	25	m

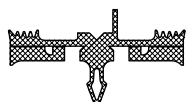

Transom				
GD5207	Inner gasket	50	25	m
GD6208	Inner gasket	60	25	m
GD8208	Inner gasket	80	25	m

Roof system | height 14 mm | overlapping

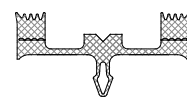

Item	Designation	System	PU	[..]
Mullion				
GD6230	Inner gasket	60	25	m

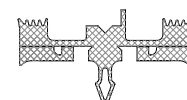

Transom				
GD6231	Inner gasket	60	25	m

Stabalux H - System screws

Cylinder head screw \varnothing 10 mm | with hexagon socket | with sealing washer

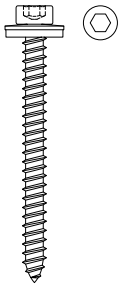

Item	Designation	Dimensions	PU	[..]
Z0327	Cylinder head screw	6,5 x 70 mm	200	pc.
Z0329	Cylinder head screw	6,5 x 80 mm	200	pc.
Z0331	Cylinder head screw	6,5 x 90 mm	200	pc.
Z0333	Cylinder head screw	6,5 x 100 mm	200	pc.
Z0335	Cylinder head screw	6,5 x 110 mm	200	pc.
Z0337	Cylinder head screw	6,5 x 120 mm	200	pc.
Z0339	Cylinder head screw	6,5 x 130 mm	200	pc.

Cylinder head screw \varnothing 10 mm | with hexagon socket | without sealing washer

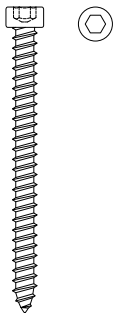

Item	Designation	Dimensions	PU	[..]
Z0727	Cylinder head screw	6,5 x 70 mm	250	pc.
Z0729	Cylinder head screw	6,5 x 80 mm	250	pc.
Z0731	Cylinder head screw	6,5 x 90 mm	200	pc.
Z0733	Cylinder head screw	6,5 x 100 mm	200	pc.
Z0735	Cylinder head screw	6,5 x 110 mm	200	pc.
Z0737	Cylinder head screw	6,5 x 120 mm	200	pc.

Washer



Item	Designation	Dimensions	PU	[..]
Z0033	PA-washer	\varnothing 10 x 1,5 mm	100	pc.
Z0046	Washer stainless steel	with 2 mm seal	100	pc.
Z0086	Washer stainless steel	with 4 mm seal	100	pc.

Stabalux H - Glass support

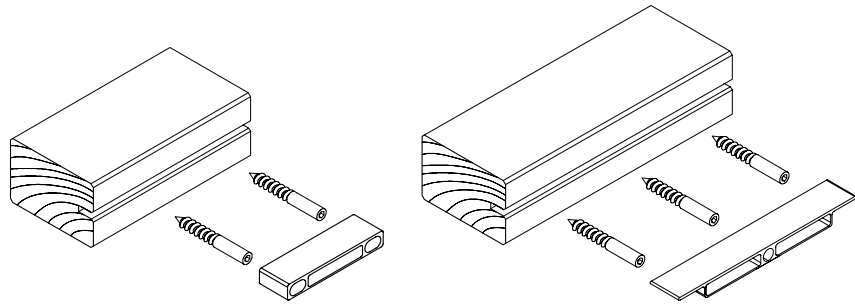

Glass support for bolts \varnothing 10 mm to max. 54 mm glass thickness

The use of the glass supports can be found in the processing instructions

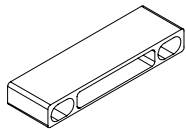

Item	Designation	Dimensions (width 102 mm)	PU	[..]
GH0081	Glass support	Depth 9 mm	1	pc.
GH0082	Glass support	Depth 24 mm	1	pc.
GH0083	Glass support	Depth 26 mm	1	pc.
GH0084	Glass support	Depth 28 mm	1	pc.
GH0085	Glass support	Depth 30 mm	1	pc.
GH0886	Glass support	Depth 32 mm	1	pc.
GH0887	Glass support	Depth 35 mm	1	pc.
GH0888	Glass support	Depth 38 mm	1	pc.
GH0889	Glass support	Depth 41 mm	1	pc.
GH0890	Glass support	Depth 44 mm	1	pc.
GH0891	Glass support	Depth 47 mm	1	pc.
GH0892	Glass support	Depth 50 mm	1	pc.
GH0893	Glass support	Depth 53 mm	1	pc.
GH0894	Glass support	Depth 56 mm	1	pc.
GH5053	Glass support	Extrudes profil	6	m

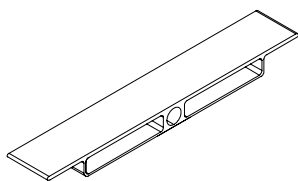

Item	Designation	Dimensions (width 200 mm)	PU	[..]
GH0851	Glass support	Depth 26 mm	1	pc.
GH0852	Glass support	Depth 28 mm	1	pc.
GH0853	Glass support	Depth 30 mm	1	pc.
GH0854	Glass support	Depth 32 mm	1	pc.
GH0855	Glass support	Depth 35 mm	1	pc.
GH0856	Glass support	Depth 38 mm	1	pc.
GH0857	Glass support	Depth 41 mm	1	pc.
GH0858	Glass support	Depth 44 mm	1	pc.
GH0859	Glass support	Depth 47 mm	1	pc.
GH0860	Glass support	Depth 50 mm	1	pc.
GH0861	Glass support	Depth 53 mm	1	pc.
GH0862	Glass support	Depth 56 mm	1	pc.

Stair screw | glavaniced | thread length 45 mm

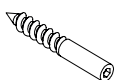

Item	Designation	Dimensions	PU	[..]
Z0371	Stair screw	\varnothing 10 x 70 mm	100	pc.
Z0372	Stair screw	\varnothing 10 x 77 mm	100	pc.
Z0373	Stair screw	\varnothing 10 x 90 mm	100	pc.

Stabalux H - Glass support

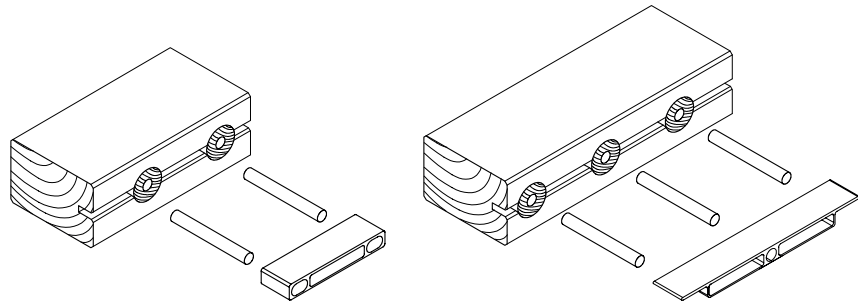

Wooden cylinder | oak | inside diameter Ø10 mm



Item	Designation	Dimensions	PU	[..]
Z0073	Oak cylinder	30 x 50 mm	100	pc.

Cylinder pin for Z0073

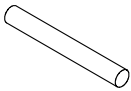

Item	Designation	Dimensions	PU	[..]
Z0047	Cylinder pin	Ø10 x 70 mm	100	pc.
Z0048	Cylinder pin	Ø10 x 80 mm	100	pc.
Z0049	Cylinder pin	Ø10 x 90 mm	100	pc.
Z0051	Cylinder pin	Ø10 x 100 mm	100	pc.
Z0050	Cylinder pin	Ø10 x 120 mm	100	pc.

Screwed glass support GH 5201 | GH 5202 up to 64 mm glass thickness

The use of the glass supports can be found in the processing instructions

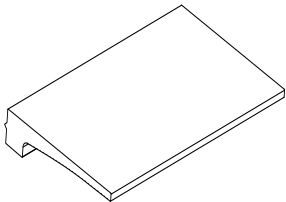

Item	Designation	Dimensions (width x depth)	PU	[..]
GH 5201	Glass support (with 3 screws)	100 mm x 65 mm	1	Stk.
GH 5202	Glass support (with 6 screws)	200 mm x 65 mm	1	Stk.

Screw connection

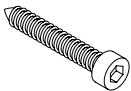

Item	Designation	Dimensions	PU	[..]
Z0731	Screw for GH5201 GH 5202	6,5 x 90 mm	200	Stk.

Stabalux AK - System profile

Add-on channel aluminium

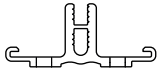

Item	Designation	PU	[..]
AK 5010	Add-on channel brute Slot hole 5,4 x 7,2 mm every 200 mm	6	m
AK6010	Add-on channel brute Slot hole 5,4 x 7,2 mm every 200 mm	6	m

Mounting of the AK6010 / AK5010 on timber

Torx wood screw | without sealing washer | for screw connection, see processing instructions

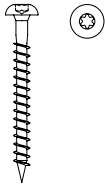

Item	Designation	Dimensions	PU	[..]
Z0170	Torx wood screw	5,0 x 50 mm	200	pc.

Stabalux AK - glass support

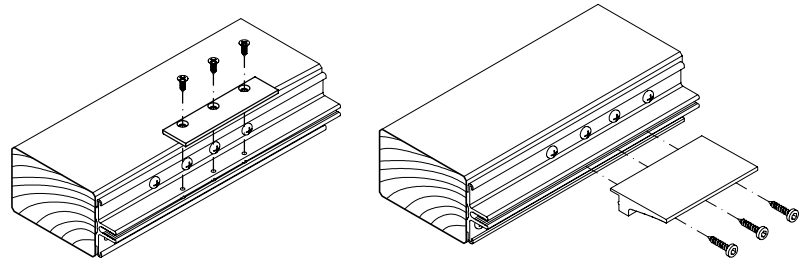

Glass support for Stabalux AK; from 20 mm up to 60 mm glass thickness

Use according to glass thickness and weight see processing instructions

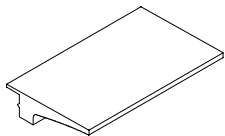

Item	Designation	Dimensions (width x depth)	PU	[..]
GH6071	Glass support	100 mm x 61,5 mm	1	pc.
GH6072	Glass support	200 mm x 61,5 mm	1	pc.

Screw to fix glass support GH6071/GH6072

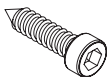

Item	Designation	Dimensions	PU	[..]
Z0247	Cylinder head screw for GH	6,3 x 25 mm	200	pc.

Glass support for Stabalux AK; from 10 mm up to 18 mm glass thickness

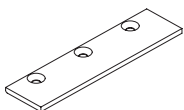

Item	Designation	Dimensions (width x depth)	PU	[..]
GH6073	Glass support	flat - 100 mm x 25 mm	1	pc.

Screw to fix glass support GH6073



Item	Designation	Dimensions	PU	[..]
Z0193	Screw for GH 6073	4,2 x 13 mm	100	pc.

Stabalux AK - Inner gasket | Facade

2-level gasket | height 16.5 mm | overlapping

Item	Designation	System	PU	[..]
Mullion				
GD5071	Inner gasket	50	25	m
GD6071	Inner gasket	60	25	m
GD8071	Inner gasket	80	25	m
Transom				
GD5072	Inner gasket	50	25	m
GD6072	Inner gasket	60	25	m
GD8072	Inner gasket	80	25	m
Sealing piece for transom end (to use with connection paste Z0094)				
Z0062	Sealing piece EPDM (Transom)	50, 60, 80	50	pc.

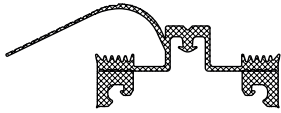
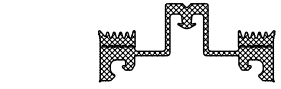

Polygonal glazing Mullion

Outer corner with 3° to 15°

GD6074	Inner gasket	60	25	m
--------	--------------	----	----	---

in combination with 2-part outer gasket GD1925



Stabalux AK - Inner gasket | Roof

2-level gasket | height 16.5 mm | overlapping

Item	Designation	System	PU	[..]
Mullion/rafter				
GD5071	Inner gasket	50	25	m
GD6071	Inner gasket	60	25	m
GD8071	Inner gasket	80	25	m
Transom				
GD5073	Inner gasket	50	25	m
GD6073	Inner gasket	60	25	m
GD8073	Inner gasket	80	25	m
Sealing piece for transom end (to use with connection paste Z0094)				
Z0062	Sealing piece EPDM (transom)	50, 60, 80	50	pc.

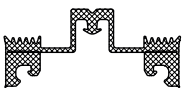
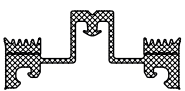

2-level gasket | height 22,5 mm | overlapping

Item	Designation	System	PU	[..]
Mullion/rafter				
GD6081	Inner gasket (≥ 4mm glass)	60	25	m
Transom				
GD6083	Inner gasket (≥ 4mm glass)	60	25	m

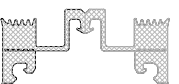
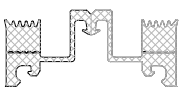

Stabalux AK-H - System screws

Stainless steel screw with cutting groove | sliding coated

Cylinder head screw \varnothing 10 mm | with hexagon socket | **with** sealing washer



Item	Designation	Dimensions	PU	[..]
Z0148	Cylinder head screw	6,3 x 30 mm	200	pc.
Z0149	Cylinder head screw	6,3 x 35 mm	200	pc.
Z0151	Cylinder head screw	6,3 x 40 mm	200	pc.
Z0152	Cylinder head screw	6,3 x 45 mm	200	pc.
Z0153	Cylinder head screw	6,3 x 50 mm	200	pc.
Z0154	Cylinder head screw	6,3 x 55 mm	200	pc.
Z0155	Cylinder head screw	6,3 x 60 mm	200	pc.
Z0156	Cylinder head screw	6,3 x 65 mm	200	pc.
Z0157	Cylinder head screw	6,3 x 70 mm	200	pc.
Z0158	Cylinder head screw	6,3 x 75 mm	200	pc.
Z0161	Cylinder head screw	6,3 x 80 mm	200	pc.
Z0162	Cylinder head screw	6,3 x 85 mm	200	pc.
Z0163	Cylinder head screw	6,3 x 90 mm	200	pc.
Z0164	Cylinder head screw	6,3 x 95 mm	200	pc.
Z0165	Cylinder head screw	6,3 x 100 mm	250	pc.
Z0167	Cylinder head screw	6,3 x 110 mm	200	pc.
Z0166	Cylinder head screw	6,3 x 120 mm	200	pc.

Stainless steel screw with cutting groove | sliding coated

Cylinder head screw \varnothing 10 mm | with hexagon socket | **without** sealing washer

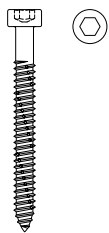

Item	Designation	Dimensions	PU	[..]
Z0293	Cylinder head screw	6,3 x 18 mm	250	pc.
Z0247	Cylinder head screw	6,3 x 25 mm	200	pc.
Z0253	Cylinder head screw	6,3 x 50 mm	250	pc.
Z0255	Cylinder head screw	6,3 x 60 mm	200	pc.
Z0257	Cylinder head screw	6,3 x 70 mm	200	pc.
Z0258	Cylinder head screw	6,3 x 75 mm	200	pc.
Z0241	Cylinder head screw	6,3 x 80 mm	200	pc.
Z0242	Cylinder head screw	6,3 x 85 mm	200	pc.
Z0243	Cylinder head screw	6,3 x 90 mm	200	pc.

Washer



Item	Designation	Dimensions	PU	[..]
Z0033	PA-washer	\varnothing 10 x 1,5 mm	100	pc.
Z0046	Washer stainless steel	with 2 mm seal	100	pc.
Z0086	Washer stainless steel	with 4 mm seal	100	pc.



Outer gasket | Facade

1-piece outer gasket

Item	Designation	System	PU	[..]
GD5024	Outer gasket	50	25	m
GD6024	Outer gasket	60	25	m
GD6024-F30	Outer gasket	Fire protection F30	60	25 m
GD8024	Outer gasket	80	25	m
GD5054	Outer gasket	Transom	50	25 m
GD6054	Outer gasket	Transom	60	25 m
GD8054	Outer gasket	Transom	80	25 m

Outer gaskets for stainless steel bottom strips UL6110 | UL6110c

GD6022-F30	Outer gasket	Fire protection F30	60	25 m
GD6122-WK	Outer gasket	Burglar resistance RC2 RC3	60	25 m

2-piece outer gasket system 50 | 60 | 80 mm

Item	Designation	PU	[..]
GD1932	Outer gasket 2-piece 5 mm	25	m
GD1934	Outer gasket 2-piece 4 mm	25	m
GD1936	Outer gasket 2-piece 6 mm	25	m
GD1938	Outer gasket 2-piece 8 mm	25	m
GD1940	Outer gasket 2-piece 10 mm	25	m
GD1925	Outer gasket 2-piece for outside corner polygonal 3°-15°	25	m
GD1928	Outer gasket 2-piece for inner corner polygonal 3°-10°	25	m
GD1903	Outer gasket 2-piece for UL5003 UL6003 UL8003	25	m
GD1904	Outer gasket 2-piece for UL5003 UL6003 UL8003 for outside corner polygonal 3°-15°	25	m
GD6174	Outer gasket 2-piece Mullion DL5073 DL6073	25	m
GD6175	Outer gasket 2-piece Transom DL5073 DL6073	25	m

Outer gasket | Roof

1-piece outer gasket



Item	Designation	System	PU	[..]
GD5024	Outer gasket	50	25	m
GD6024	Outer gasket	60	25	m
GD8024	Outer gasket	80	25	m

Stainless steel sealing plate

(for additional tightness in sloped glazing up to 10° inclination)

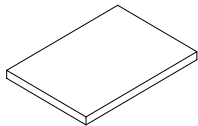

Item	Designation	Dimensions	System	PU	[..]
Z0501	Stainless steel sealing plate	60 x 40 mm	50	10	pc.
Z0601	Stainless steel sealing plate	60 x 50 mm	60	10	pc.
Z0801	Stainless steel sealing plate	70 x 70 mm	80	10	pc.

Hold-down clamp

With a roof pitch of $\leq 5^\circ$, there is no cover plate in the transom. In order to ensure that rainwater and dirt run off freely, the rebate is sealed with weather silicone. Hold-down devices are to be used to support the glass edges.

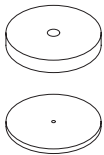

Item	Designation	Dimensions (W x H)	PU	[..]
Z0020	Hold-down stainless steel	round 50 X 8 mm	10	pc.
GD5009	Washer for Z0020	round 50 x 3 mm	50	pc.

Insulation block

When sealing the rebate area of the bolt with weather silicone, insulation blocks can serve as backfill material.

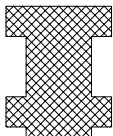

Item	Designation	Dimensions (L x W x H)	PU	[..]
Z0610	Insulation block 20 / 5,2 (flat)	2.000 x 20 x 5,2 mm	50	m
Z0609	Insulation block 20 / 10,4 (T-form)	2.000 x 20 x 10,4 mm	50	m
Z0606	Insulation block 20 / 26	2.000 x 20 x 26 mm	50	m
Z0605	Insulation block 20 / 42	2.000 x 20 x 42 mm	50	m

Pressure plates with visible screw connections

Pressure plates made of aluminum

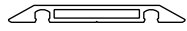

Item	Designation	Dimensions (W x H x L)	System	PU	[..]
DL5067	Pressure plate blank	50 x 6 x 6000 mm	50	6	m
DL6067	Pressure plate blank	60 x 6 x 6000 mm	60	6	m



DL5071	Pressure plate blank	50 x 6 x 6000 mm	50	6	m
DL6071	Pressure plate blank	60 x 6 x 6000 mm	60	6	m
DL6071-ELO	Pressure plate E6EV1	60 x 6 x 6000 mm	60	6	m



DL5059	Pressure plate blank	50 x 8 x 6000 mm	50	6	m
DL6059	Pressure plate blank	60 x 8 x 6000 mm	60	6	m
DL6059-ELO	Pressure plate E6EV1	60 x 8 x 6000 mm	60	6	m
DL8059	Pressure plate blank	80 x 8 x 6000 mm	80	6	m



DL5061	Pressure plate blank	50 x 25 x 6000 mm	50	6	m
DL6061	Pressure plate blank	60 x 25 x 6000 mm	60	6	m
DL6061-ELO	Pressure plate E6EV1	60 x 25 x 6000 mm	60	6	m

Pressure plates made of aluminum for SG-like glazing



Item	Designation	Dimensions (W x H x L)	System	PU	[..]
DL5073	Flat pressure plate blank	50 x 2,5 x 6000 mm	50	6	m
DL6073	Flat pressure plate blank	60 x 2,5 x 6000 mm	60	6	m

Cover plug for flat pressure plate DL5073 | DL6073



Item	Designation		PU	[..]
Z0089	Cover plug	for DL5073 DL6073	250	pc.

Stainless steel pressure plate

Upper profile 1.4571 | Sub-profile 1.4301 | sanded grain 240 | one-sided foil



Item	Designation	Dimensions (W x H x L)	System	PU	[..]
DL6044	Stainless steel pressure plate	60 x 20 x 6000 mm	60	6*	m

Lower profile perforated Ø7 mm every 125 mm

*Usable length = 5990 mm

Stainless steel pressure plates

Flat cover strip 1.4301 | 2 B



Item	Designation	Dimensions (W x H x L)	System	PU	[..]
DL6018	Stainless steel pressure plate	59 x 3 x 6000 mm	60	6	m

in combination with 2-part outer gasket GD6940

Pressure plates with concealed screw connections

Stainless steel cover plate

1.4401 | ground grit 220 | one-sided foil



Item	Designation	Dimensions (W x H x L)	System	PU	[..]
OL6064	Stainless steel cover plate	60 x 20 x 6000 mm	60	6	m

Aluminum pressure plate for OL6064

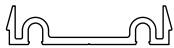

UL6007-L ¹⁾	Pressure plate	57 x 6000 mm	60	6	m
------------------------	----------------	--------------	----	---	---

Pressure plates made of aluminium

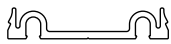

Item	Designation	Dimensions (W x L)	System	PU	[..]
UL5009	Pressure plate	46 x 6000 mm	50	6	m
UL5009-L ¹⁾	Pressure plate	46 x 6000 mm	50	6	m
UL6009	Pressure plate	54,2 x 6000 mm	60	6	m
UL6009-L ¹⁾	Pressure plate	54,2 x 6000 mm	60	6	m
UL8009-L ¹⁾	Pressure plate	76 x 6000 mm	80	6	m

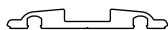

UL6005-L ¹⁾	Pressure plate	56 x 6000 mm	60	6	m
------------------------	----------------	--------------	----	---	---

Only for OL6066

Special screw cylinder head with hexagon socket without sealing washer e.g. Z0253, Z0254 etc.

¹⁾ Long hole 7 x 10 mm every 125 mm

Stainless steel pressure plates

1.4301

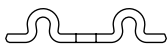

Item	Designation	Dimensions (W x L)	System	PU	[..]
UL6110 ^{2) 4)}	Stainless steel pressure plates	56 x 6000 mm	60	6 ⁵⁾	m
UL6110c ^{2) 4)}	Galvanized pressure plates	56 x 6000 mm	60	6 ⁵⁾	m

for fire protection F30 | for burglar resistance RC2

²⁾ Long hole 7 x 10 mm every 250 mm; ³⁾ for GD5122-WK; ⁴⁾ for GD6022-F30 & GD6122-WK; ⁵⁾ Useful length = 5990 mm

Cover plate made of aluminum for wood System 50 | 60 | 80 mm

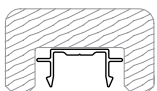

Item	Designation	Dimensions (W x H x L)	PU	[..]
OL1903	Cover plate	29,4 x 13 x 80 mm	1	pc.

Pressure plate made of aluminum for OL1903









Item	Designation	Dimensions (W x L)	System	PU	[..]
UL5003-L ¹⁾	Pressure plate	46 x 6000 mm	50	6	m
UL6003-L ¹⁾	Pressure plate	56 x 6000 mm	60	6	m
UL8003-L ¹⁾	Pressure plate	76 x 6000 mm	80	6	m

¹⁾ Long hole 7 x 10 mm every 125 mm

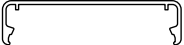
Cover plates with concealed screw connections

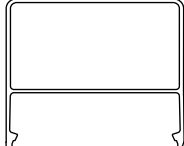
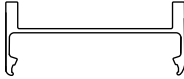
Cover plates made of aluminum

Item	Designation	Dimensions (W x H x L)	System	PU	[..]	
	OL5025	Cover plate blank	50 x 15 x 6000 mm; radius 0,5	50	6	m
	OL6011	Cover plate blank	60 x 13 x 6000 mm	60	6	m
		<i>only use with screw (e.g. Z0249) and separate sealing washer Z0033!</i>				
	OL5012	Cover plate blank	50 x 15 x 6000 mm	50	6	m
	OL6012	Cover plate blank	60 x 15 x 6000 mm	60	6	m
	OL6012-ELO	Cover plate E6EV1	60 x 15 x 6000 mm	60	6	m
	OL8012	Cover plate blank	80 x 15 x 6000 mm	80	6	m
	OL5013	Cover plate blank	50 x 18 x 6000 mm	50	6	m
	OL6013	Cover plate blank	60 x 18 x 6000 mm	60	6	m
	OL6013-ELO	Cover plate E6EV1	60 x 18 x 6000 mm	60	6	m
	OL8013	Cover plate blank	80 x 18 x 6000 mm	80	6	m
	OL5014	Cover plate blank	50 x 25 x 6000 mm	50	6	m
	OL6014	Cover plate blank	60 x 25 x 6000 mm	60	6	m
	OL6014-ELO	Cover plate E6EV1	60 x 25 x 6000 mm	60	6	m
	OL8014	Cover plate blank	80 x 25 x 6000 mm	80	6	m
	OL6015	Cover plate blank	60 x 50 x 6000 mm	60	6	m
	OL8015	Cover plate blank	80 x 50 x 6000 mm	80	6	m
	OL6081	Cover plate blank	60 x 150 x 6700 mm	60	6,7	m
	OL5016	Cover plate blank	50 x 25 x 6000 mm	50	6	m
	OL6016	Cover plate blank	60 x 25 x 6000 mm	60	6	m
	OL6066	Cover plate blank	60 x 12,3 x 6000 mm	60	6	m
		<i>Only use with UL6005!</i>				

Mullion-Transom-Connector, 2-part

Aluminum | blank | with ETA

1 pair consisting of mullion and transom connector

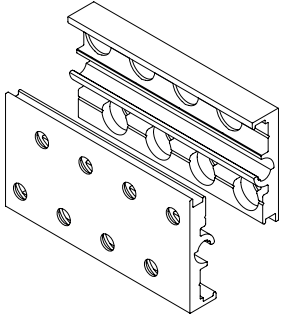

Item	Designation	Dimensions (screws)	PU	[..]
RHT8040	T-Connector wood system	for transom depth 55 - 73 mm (4)	10	pair
RHT8058	T-Connector wood system	for transom depth 74 - 91 mm (6)	10	pair
RHT8076	T-Connector wood system	for transom depth 92 - 109 mm (6)	10	pair
RHT8094	T-Connector wood system	for transom depth 110 - 145 mm (8)	10	pair
RHT8130	T-Connector wood system	for transom depth 146 - 181 mm (8)	10	pair
RHT8166	T-Connector wood system	for transom depth 182 - 235 mm (12)	10	pair
RHT8220	T-Connector wood system	for transom depth 236 - 300 mm (12)	10	pair

Screws for the transom connector



Item	Designation		PU	[..]
Z0126	V2A countersunk screw 5/50	for mullion	200	pc.
Z0127	V2A countersunk screw 5/80	for transom	200	pc.

Connection screw for coupling the RHTs



Item	Designation	Dimensions	PU	[..]
Z8040	for RHT8040	5,5 x 38 mm	10	pc.
Z8058	for RHT8058	5,5 x 50 mm	10	pc.
Z8076	for RHT8076	5,5 x 70 mm	10	pc.
Z8094	for RHT8094	5,5 x 90 mm	10	pc.
Z8166	for RHT8130/8166/8220	5,5 x 120 mm	10	pc.

Stabalux fire protection

Fire protection glasses

We deliver fire protection glass within the scope of our current approvals (Contraflam, Pyrostop and Promaglas)

Nameplates for fire protection glazing

Item	Designation		PU	[..]
Z1280	Nameplate F30 Facade	Approval Z-19.14-1280	1	pc.

Foil

Item	Designation	Dimensions	PU	[..]
Z0059	Waterproofing membrane BS	330 x 1 mm	25	m
<i>(one side smooth, other side 5 mm subdivision)</i>				

Stabalux equipment

Tools & accessories for seals

Item	Designation		PU	[..]
Z0056	Scissors		1	pc.
Z0077	Notching pliers	System 50	1	pc.
Z0078	Notching pliers	System 60	1	pc.
Z0094	Stabalux connection paste	310 ml black	1	pc.

1 box = 12 pieces

Burglar resistance accessories

Item	Designation		PU	[..]
Z1061	Blocking (side) 20x24	for RC2 RC3	6	m
Z0093	Screw locking	Stainless steel ball; Ø 5.0 mm	100	pc.

for screw locking RC2 and RC3; bonding e.g. with Z0055

Cross bars for end fields

Item	Designation	Dimensions (L x W x H)	PU	[..]
Z1061	Rigid PVC cross bars; Gray	6000 x 20 x 24 mm	6	m
Z1062	Rigid PVC cross bars; Gray	6000 x 22 x 26 mm	6	m
Z1063	Rigid PVC cross bars; Gray	6000 x 28 x 30 mm	6	m
Z1064	Rigid PVC cross bars; Gray	6000 x 32 x 34 mm	6	m
Z1065	Rigid PVC cross bars; Gray	6000 x 36 x 38 mm	6	m
Z1066	Rigid PVC cross bars; Gray	6000 x 40 x 42 mm	6	m

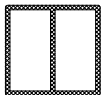

Insulation blocks for the glass rebate area



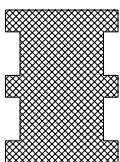

with permanent HOT-MELT; insert with split seal

Item	Designation	Dimensions (L x W x H)	PU	[..]
Rebate width 20 mm				
Z0606	Insulation block 20 / 26	2000 x 20 x 26 mm	50	m
Z0605	Insulation block 20 / 42	2000 x 20 x 42 mm	50	m
Rebate width 30 mm				
Z0608	Insulation block 30 / 26	2000 x 30 x 26 mm	50	m
Z0607	Insulation block 30 / 42	2000 x 30 x 42 mm	50	m



Gaskets | System-independent

Gaskets without radius

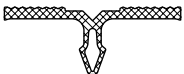
Item	Designation	System	PU	[..]
	GD5940 Gasket height 5 mm	50	25	m
	GD6940 Gasket height 5 mm	60	25	m
	GD6940-G30 Gasket height 5 mm fire protection G30	60	25	m
	GD6940-F30 Gasket height 5 mm fire protection F30	60	25	m
	GD6026 Gasket height 5 mm mullion/transom	60	25	m
	GD0035 Gasket self-adhesive 14 x 5 mm		100	m
	SG990011GD Inner gasket height 3 mm	50	25	m
	SG990002GD Inner gasket height 3 mm	45	25	m
	SG990001GD Inner gasket height 3 mm	50	25	m

Gaskets with radius 3 mm

	GD5915-SK Gasket self-adhesive	50	25	m
	GD6916-SK Gasket self-adhesive	60	25	m



Gaskets with radius 8 mm

	GD5921 Inner gasket	50	25	m
	GD5921-SK Gasket self-adhesive	50	25	m

Gaskets with radius 12 mm

	GD5925 Inner gasket	50	25	m
---	---------------------	----	----	---

Gasket sloping glazing with a radius of 3 mm

Item	Designation	System	PU	[..]
Mullion				
	GD6946 Inner gasket	60	25	m
Transom				
	GD5901 Inner gasket	50	25	m
	GD6902 Inner gasket	60	25	m