



## General informations

### Item information

For individual items, the dimensions can be read from the item number.

- Gaskets – GD5201-G30 | Width 50 mm / Fire protection G30
- Cover and pressure plates – DL5067-ELO | Width 50 mm / anodized

Articles with article numbers beginning with 50 are for systems with a width of 50 mm.

### Articel availability

Normally all items listed with a price are in stock and can be delivered immediately.

### Packing units [PU]

- Gaskets (GD) 25 m in a box (unless otherwise specified).
- Screws and bolts, depending on the version, 100 pieces or 200 pieces in a box.
- Tubes, profiles and bar stock per specified storage length.
- Special accessories, tools and various small items per version 1 pc. or 10 pc.

Order quantities that differ from the packaging units [PU] are confirmed and delivered in the next higher PU.

With surface-processed cover strips, the usable length is reduced by approx. 50 mm at the profile ends.

Special lengths for bar goods (screw tubes, T-profiles, top, cover and bottom strips) on request.

The technical drawings shown in the price list are not to scale. For technical details, see product information.

**We do not accept any liability for errors or misprints.**

### Order

Please fax or email your order to our order processing department:

Fax: **+49 228 909043-11**  
Mail: **c.service@stabalux.com**

### Stabalux GmbH

Fraunhoferstraße 8  
53121 Bonn - Germany  
Phone +49 228 909043-0  
Fax +49 228 909043-11  
info@stabalux.com

## Stabalux AL Threaded Tubes | AW 6060 T66

Item	Designation	Dimensions	PU	[..]
<b>System 50</b>				
AL5040	AL tube   AW 6060 T66	50x40 / 6000 mm	6	m
AL5060	AL tube   AW 6060 T66	50x60 / 6000 mm	6	m
AL5090	AL tube   AW 6060 T66	50x90 / 6000 mm	6	m
AL50120	AL tube   AW 6060 T66	50x120 / 6000 mm	6	m
AL50120-R	AL tube   AW 6060 T66	50x120 / 6000 mm   radius 2 mm	6	m
AL50150	AL tube   AW 6060 T66	50x150 / 6000 mm	6	m
AL50150-R	AL tube   AW 6060 T66	50x150 / 6000 mm   radius 2 mm	6	m
AL50200	AL tube   AW 6060 T66	50x200 / 6000 mm	6	m
AL50250	AL tube   AW 6060 T66	50x250 / 6000 mm	6	m
AL9090	AL tube   AW 6060 T66	90x90 / 6000 mm   corner profile	6	m

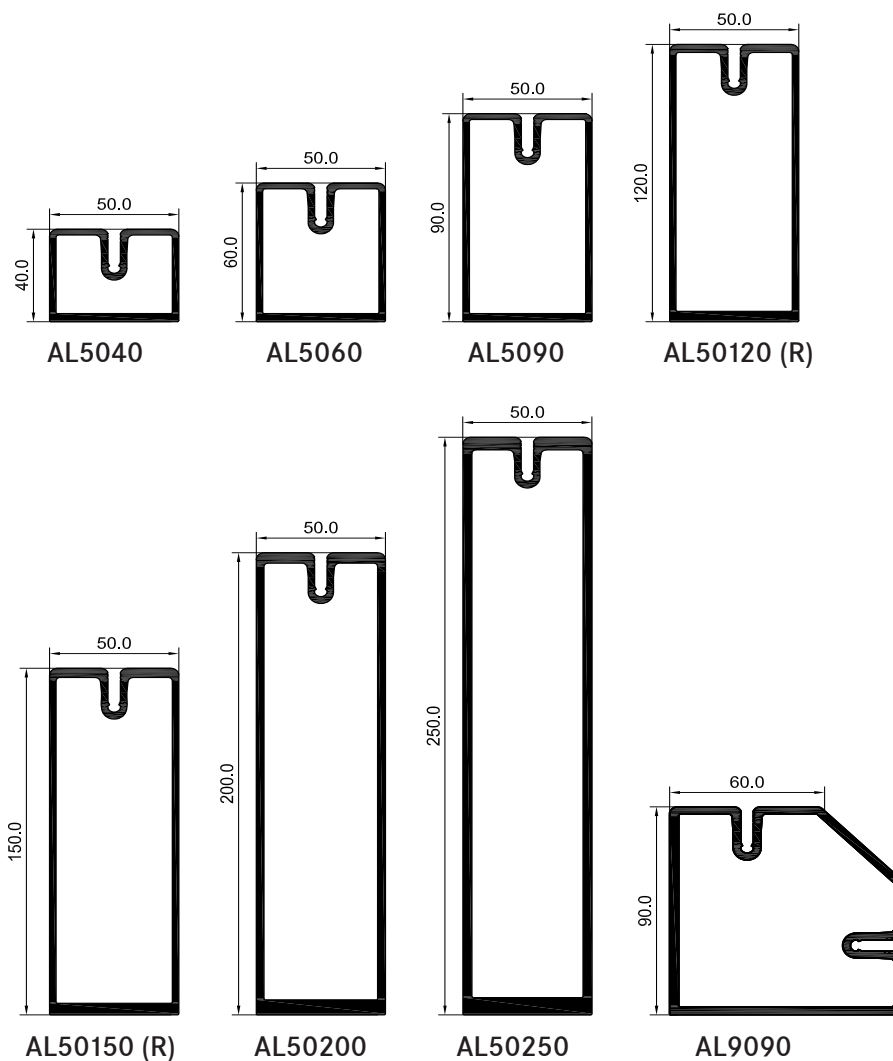

## Stabalux AL - Mullion-Transom-Connector

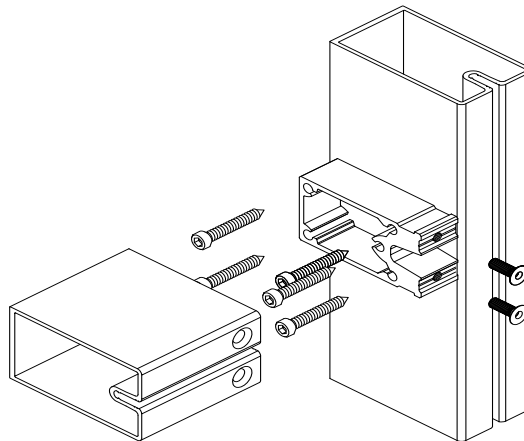

### T-Connector aluminum

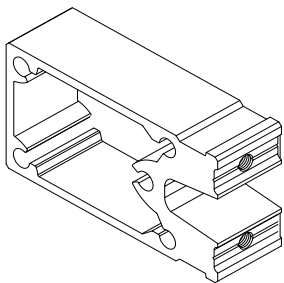

Item	Designation	Dimensions	System	PU	[..]
TVA 5040	T-Connector for AL5040	44,4 x 33 x 25 mm (2)	50	1	pc.
TVA 5060	T-Connector for AL5060	44,4 x 53 x 25 mm (5)	50	1	pc.
TVA 5090	T-Connector for AL5090	44,4 x 83 x 25 mm (5)	50	1	pc.
TVA 50120	T-Connector for AL50120	44,4 x 111 x 25 mm (5)	50	1	pc.
TVA 50150	T-Connector for AL50150	44,4 x 140 x 25 mm (5)	50	1	pc.
TVA 50200	T-Connector for AL50200	43,4 x 188 x 25 mm (5)	50	1	pc.
TVA 50250	T-Connector for AL50250	43,4 x 236 x 25 mm (5)	50	1	pc.

### Screws

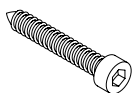

Item	Designation	Dimensions	PU	[..]
Z0118	Screw for T-Connector	6,3 x 40 mm	200	pc.
Z0128	Fixing screw transom	M6 x 18 mm	200	pc.

## Stabalux AL - Glass support

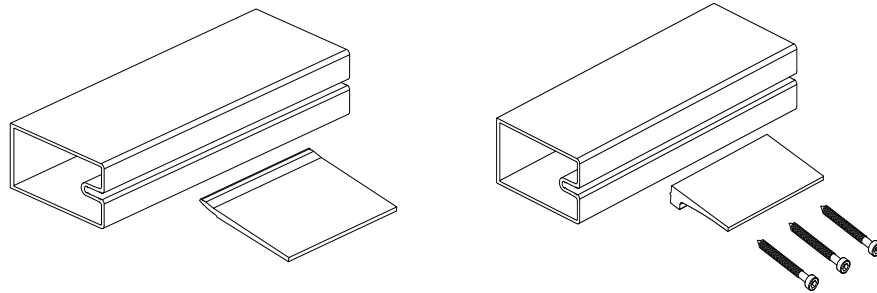

### Screwed glass support GH 5201 | GH 5202

for glass thickness up to 64 mm

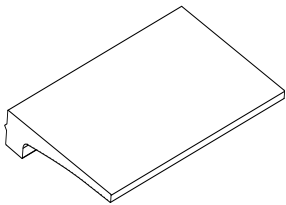

Item	Designation	Width x depth	PU	[..]
GH 5201	Glass support (3 screws)	100 mm x 65 mm	1	Stk.
GH 5202	Glass support (6 screws)	200 mm x 65 mm	1	Stk.

### Screw connection

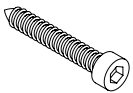

Item	Designation	Dimensions	PU	[..]
Z0118	Screw for GH5201   GH 5202	6,3 x 40 mm	200	Stk.

### Insert glass support GH 5101 | GH 5102

for glass thickness up to 70 mm

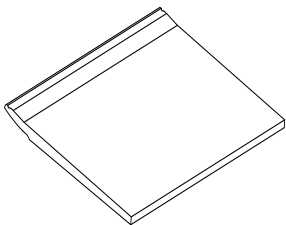

Item	Designation	Width x depth	PU	[..]
GH 5101	Glass support	100 mm x 90,6 mm	1	Stk.
GH 5102	Glass support	200 mm x 90,6 mm	1	Stk.

## Stabalux AL - Inner gasket | Facade

### Gasket | height 5 mm | butt joint

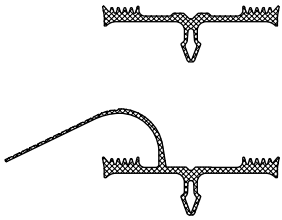

Item	Designation	System	PU	[..]
<b>Mullion</b>				
GD5201	Inner gasket   2 and 3 mm	50	25	m
<b>Transom</b>				
GD5203	Inner gasket   2 and 3 mm	50	25	m
GD5204	Inner gasket   2 and 3 mm   (Glass $\geq$ 50 mm)	50	25	m

### 3-level gasket | height 12 mm | overlapping

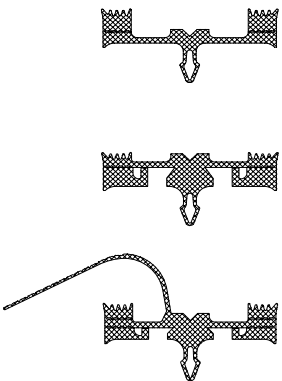

Item	Designation	System	PU	[..]
<b>Main mullion</b>				
GD5314	Inner gasket   2 and 3 mm	50	25	m
<b>Secondary mullion</b>				
GD5315	Inner gasket   2 and 3 mm	50	25	m
<b>Transom</b>				
GD5317	Inner gasket   2 and 3 mm (Glass $\leq$ 50 mm)	50	25	m

## Stabalux AL - Inner gasket | Roof

### Roof system | height 10 mm | overlapping

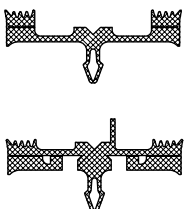

Item	Designation	System	PU	[..]
<b>Mullion</b>				
GD5205	Inner gasket   2 and 3 mm	50	25	m
<b>Transom</b>				
GD5207	Inner gasket   2 and 3 mm	50	25	m

## Outer gasket | Facade

### 1-piece outer gasket

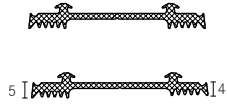

Item	Designation	System	PU	[..]
GD5024	Outer gasket	50	25	m
GD5054	Outer gasket	Transom	50	25 m

### 2-piece outer gasket system 50 mm

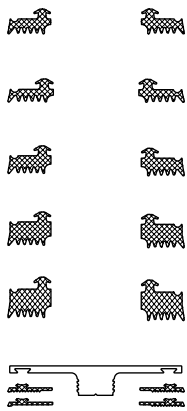

Item	Designation	PU	[..]
GD1932	Outer gasket   2-piece 5 mm	25	m
GD1934	Outer gasket   2-piece 4 mm	25	m
GD1936	Outer gasket   2-piece 6 mm	25	m
GD1938	Outer gasket   2-piece 8 mm	25	m
GD1940	Outer gasket   2-piece 10 mm	25	m
GD6174	Outer gasket   2-piece Mullion DL5073	25	m
GD6175	Outer gasket   2-piece Transom DL5073	25	m

## Outer gasket | Roof

### 1-piece outer gasket



Item	Designation	System	PU	[..]
GD5024	Outer gasket	50	25	m

### Stainless steel sealing plate

*(for additional tightness in sloped glazing up to 10° inclination)*

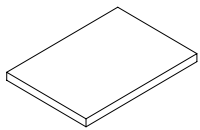

Item	Designation	Dimensions	System	PU	[..]
Z0501	Stainless steel sealing plate	60 x 40 mm	50	10	pc.

### Hold-down clamp for roof systems

*With a roof pitch ≤ 5°, there is no cover plate in the transom. In order to ensure that rainwater and dirt run off freely, the rebate is sealed with weather silicone. Hold-down devices are to be used to support the glass edges.*

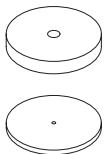

Item	Designation	Dimensions (W x H)	PU	[..]
Z0020	Hold-down stainless steel	round   50 x 8 mm	10	pc.
GD5009	Washer for Z0020	round   50 x 3 mm	50	pc.

### Insulation block

*When sealing the rebate area of the bolt with weather silicone, insulation blocks can serve as backfill material.*

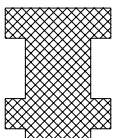

Item	Designation	Dimensions (L x W x H)	PU	[..]
Z0610	Insulation block 20 / 5,2 (flat)	2.000 x 20 x 5,2 mm	50	m
Z0609	Insulation block 20 / 10,4 (T-form)	2.000 x 20 x 10,4 mm	50	m
Z0606	Insulation block 20 / 26	2.000 x 20 x 26 mm	50	m
Z0605	Insulation block 20 / 42	2.000 x 20 x 42 mm	50	m



## Pressure plates with visible screw connections

### Pressure plates made of aluminum

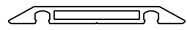

Item	Designation	Dimensions (W x H x L)	System	PU	[..]
DL5067	Pressure plate blank	50 x 6 x 6000 mm	50	6	m

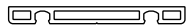

DL5071	Pressure plate blank	50 x 6 x 6000 mm	50	6	m
--------	----------------------	------------------	----	---	---

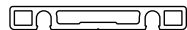

DL5059	Pressure plate blank	50 x 8 x 6000 mm	50	6	m
--------	----------------------	------------------	----	---	---



DL5061	Pressure plate blank	50 x 25 x 6000 mm	50	6	m
--------	----------------------	-------------------	----	---	---

### Pressure plates made of aluminum for SG-like glazing



Item	Designation	Dimensions (W x H x L)	System	PU	[..]
DL5073	Flat pressure plate blank	50 x 2,5 x 6000 mm	50	6	m

### Cover plug for flat pressure plate DL5073



Item	Designation	PU	[..]
Z0089	Cover plug for DL5073	250	pc.

## Pressure plates with concealed screw connections

### Pressure plates made of aluminum



Item	Designation	Dimensions (W x L)	System	PU	[..]
UL5009	Pressure plate blank	46 x 6000 mm	50	6	m
UL5009-L <sup>1)</sup>	Pressure plate blank	46 x 6000 mm	50	6	m

<sup>1)</sup> Long hole 7 x 10 mm every 125 mm

### Cover plates made of aluminum

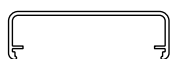

Item	Designation	Dimensions (W x H x L)	System	PU	[..]
OL5025	Cover plate blank	50 x 15 x 6000 mm   radius 0,5	50	6	m
OL5012	Cover plate blank	50 x 15 x 6000 mm	50	6	m
OL5013	Cover plate blank	50 x 18 x 6000 mm	50	6	m
OL5014	Cover plate blank	50 x 25 x 6000 mm	50	6	m
OL5016	Cover plate blank	50 x 25 x 6000 mm	50	6	m

## Stabalux - System screws

### Stainless steel screw with cutting groove | sliding coated

Cylinder head screw  $\varnothing$  10 mm | with hexagon socket | **with** sealing washer



Item	Designation	Dimensions	PU	[..]
Z0148	Cylinder head screw	6,3 x 30 mm	200	pc.
Z0149	Cylinder head screw	6,3 x 35 mm	200	pc.
Z0151	Cylinder head screw	6,3 x 40 mm	200	pc.
Z0152	Cylinder head screw	6,3 x 45 mm	200	pc.
Z0153	Cylinder head screw	6,3 x 50 mm	200	pc.
Z0154	Cylinder head screw	6,3 x 55 mm	200	pc.
Z0155	Cylinder head screw	6,3 x 60 mm	200	pc.
Z0156	Cylinder head screw	6,3 x 65 mm	200	pc.
Z0157	Cylinder head screw	6,3 x 70 mm	200	pc.
Z0158	Cylinder head screw	6,3 x 75 mm	200	pc.
Z0161	Cylinder head screw	6,3 x 80 mm	200	pc.
Z0162	Cylinder head screw	6,3 x 85 mm	200	pc.
Z0163	Cylinder head screw	6,3 x 90 mm	200	pc.
Z0164	Cylinder head screw	6,3 x 95 mm	200	pc.
Z0165	Cylinder head screw	6,3 x 100 mm	250	pc.
Z0167	Cylinder head screw	6,3 x 110 mm	200	pc.
Z0166	Cylinder head screw	6,3 x 120 mm	200	pc.

### Stainless steel screw with cutting groove | sliding coated

Cylinder head screw  $\varnothing$  10 mm | with hexagon socket | **without** sealing washer

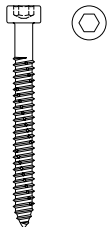

Item	Designation	Dimensions	PU	[..]
Z0293	Cylinder head screw	6,3 x 18 mm	250	pc.
Z0247	Cylinder head screw	6,3 x 25 mm	200	pc.
Z0253	Cylinder head screw	6,3 x 50 mm	250	pc.
Z0255	Cylinder head screw	6,3 x 60 mm	200	pc.
Z0257	Cylinder head screw	6,3 x 70 mm	200	pc.
Z0258	Cylinder head screw	6,3 x 75 mm	200	pc.
Z0241	Cylinder head screw	6,3 x 80 mm	200	pc.
Z0242	Cylinder head screw	6,3 x 85 mm	200	pc.
Z0243	Cylinder head screw	6,3 x 90 mm	200	pc.

### Washer



Item	Designation	Dimensions	PU	[..]
Z0033	PA washer	$\varnothing$ 10 (6,3) x 1,5 mm	100	pc.
Z0046	Washer stainless steel	with 2 mm seal	100	pc.
Z0086	Washer stainless steel	with 4 mm seal	100	pc.

## Stabalux Equipment

### Tools & accessories for seals

Item	Designation		PU	[..]
Z0056	Scissors		1	pc.
Z0077	Notching pliers	System 50	1	pc.
Z0094	Stabalux connection paste	310 ml   black	1	pc.
<i>1 box = 12 pieces</i>				

### Cross bars for end fields

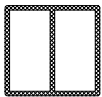

Item	Designation	Dimensions (L x W x H)	PU	[..]
Z1061	rigid PVC cross bars; gray	6000 x 20 x 24 mm	6	m
Z1062	rigid PVC cross bars; gray	6000 x 22 x 26 mm	6	m
Z1063	rigid PVC cross bars; gray	6000 x 28 x 30 mm	6	m
Z1064	rigid PVC cross bars; gray	6000 x 32 x 34 mm	6	m
Z1065	rigid PVC cross bars; gray	6000 x 36 x 38 mm	6	m
Z1066	rigid PVC cross bars; gray	6000 x 40 x 42 mm	6	m

### Insulation blocks for the glass rebate area



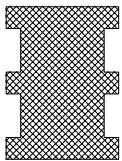

*with permanent HOT-MELT; insert with split seal*

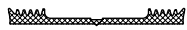

Item	Designation	Dimensions (L x W x H)	PU	[..]
<b>Rebate width 20 mm</b>				
Z0606	insulation block 20 / 26	2000 x 20 x 26 mm	50	m
Z0605	insulation block 20 / 42	2000 x 20 x 42 mm	50	m

## Gaskets | System-independent

### Gaskets without radius

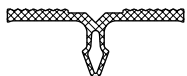
Item	Designation	System	PU	[..]
	GD5940 Gasket   height 5 mm	50	25	m
	GD6940 Gasket   height 5 mm	60	25	m
	GD6940-G30 Gasket   height 5 mm   fire protection G30	60	25	m
	GD6940-F30 Gasket   height 5 mm   fire protection F30	60	25	m
	GD6026 Gasket   height 5 mm   mullion/transom	60	25	m
	GD0035 Gasket   self-adhesive   14 x 5 mm		100	m
	SG990011GD Inner gasket height 3 mm	50	25	m
	SG990002GD Inner gasket height 3 mm	45	25	m
	SG990001GD Inner gasket height 3 mm	50	25	m

### Gaskets with radius 3 mm

	GD5915-SK Gasket   self-adhesive	50	25	m
	GD6916-SK Gasket   self-adhesive	60	25	m



### Gaskets with radius 8 mm

	GD5921 Inner gasket	50	25	m
	GD5921-SK Gasket   self-adhesive	50	25	m

### Gaskets with radius 12 mm

	GD5925 Inner gasket	50	25	m
---	---------------------	----	----	---

### Gasket sloping glazing with a radius of 3 mm

Item	Designation	System	PU	[..]
<b>Mullion</b>				
	GD6946 Inner gasket	60	25	m
<b>Transom</b>				
	GD5901 Inner gasket	50	25	m
	GD6902 Inner gasket	60	25	m